



PRISM QUARTZ • GRANITE • SLIMLINE QUARTZ • CULTURED MARBLE
SOLID SURFACE • CUSTOM LAMINATE • POSTFORM • FLEXLINE • AND MORE

PRISM QUARTZ VANITY TOPS

DISTINCTIVE. BEAUTIFUL. CONTEMPORARY.



Ease of care and elegant design are built into Prism Quartz Vanity Tops, providing you with long-lasting beauty and exceptional value. Each is fabricated from tough quartz minerals, creating a surface that is harder and more scratch resistant than granite or marble. The nonporous, easy-care surface is highly resistant to stains.

PERFECT FOR

- Distinctive Homes
- Luxury Accommodations
- Hospitality & Business Centers

OPTIONS

- 12 Colors
- 2cm and 3cm Thickness
- Standard Lengths:
25", 31", 37", 43", 49", 61" and 73"
- Custom Sizes up to 120" long
- Standard Depths: 19¼" and 22¼"
- Undermount Porcelain Bowls in
Oval or Rectangular
- Custom Bowl Cutouts Available
- Standard Eased Edge
- 4 Custom Edge Profiles
- 4" Loose Backsplash

EASY ORDER, QUICK DELIVERY

Just complete the order process with your design consultant, and you can have your beautiful Prism Quartz Vanity Tops in as little as two weeks. Custom orders take less than three weeks.

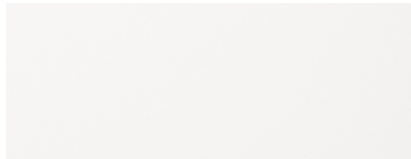
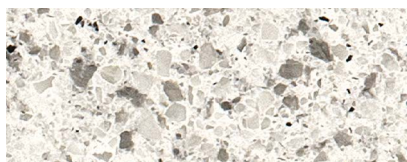
**Q-3007** Porcelain White**Q-3009** Carrara Verta**Q-3003** White Pearl**Q-3011** Stormy Gray**Q-3012** Terra Gray**Q-3013** Copper Sand**Q-3001** Polar White**NEW Q-3016** Miami Ora**NEW Q-3017** Calacatta Premata**Q-3010** Iceberg**Q-1002** Ocean Gray**Q-3006** Gray Pearl

EIGHT REASONS TO CHOOSE PRISM QUARTZ VANITY TOPS

- 1 | **Enduring Style** / Prism Quartz by Rynone vanity tops come in rich colors and classic patterns to create contemporary and timeless designs.
- 2 | **Radiant Beauty** / Prism Quartz by Rynone makes for beautiful, natural-looking vanity tops that enhance the appearance of any home.
- 3 | **Highly Durable** / Rynone uses a nonporous quartz surface material that is heat, scratch and stain resistant. Because it is also mold and mildew resistant, sealers are unnecessary.
- 4 | **Easy Care** / Prism Quartz by Rynone can usually be cleaned with soap and water.
- 5 | **Superior Quality** / Prism Quartz Vanity Tops are tough, resilient and can last a lifetime. That's a sound home investment.
- 6 | **Fast Delivery** / A huge stock of Prism Quartz Vanity Tops is ready to ship in as little as two weeks. Custom orders take less than three weeks.
- 7 | **Sustainably Made** / Rynone uses eco-friendly processes to manufacture its vanity tops.
- 8 | **Trusted Source** / Rynone has the capabilities, resources and commitment to deliver what we promise.

PRISM QUARTZ VANITY TOPS

MULTIPLIER

2CM STANDARD LIST PRICING

All depths indicated are 19¼" or 22¼".

INCLUDES:

- 4" Loose Backsplash
- Porcelain Oval or Rectangular Bowl
- Eased Front & Two Finished Ends

	PRISM QUARTZ BY RYNONE			
	GROUP 1	GROUP 2	GROUP 3	GROUP 4
	Q-1002 Ocean Gray Q-3001 Polar White Q-3007 Porcelain White Q-3010 Iceberg	Q-3009 Carrara Verta Q-3012 Terra Gray Q-3016 Miami Ora	Q-3006 Gray Pearl Q-3011 Stormy Gray Q-3017 Calacatta Premata	Q-3013 Copper Sand Q-3003 White Pearl
25" x 19"	\$660.00	\$700.00	\$790.00	\$910.00
31" x 19"	\$750.00	\$810.00	\$910.00	\$1,050.00
37" x 19"	\$830.00	\$910.00	\$1,020.00	\$1,190.00
49" x 19"	\$1,000.00	\$1,100.00	\$1,250.00	\$1,470.00
25" x 22"	\$660.00	\$700.00	\$790.00	\$910.00
31" x 22"	\$750.00	\$810.00	\$910.00	\$1,050.00
37" x 22"	\$830.00	\$910.00	\$1,020.00	\$1,190.00
43" x 22"	\$910.00	\$1,010.00	\$1,140.00	\$1,330.00
49" x 22"	\$1,000.00	\$1,100.00	\$1,250.00	\$1,470.00
61" x 22"	\$1,160.00	\$1,290.00	\$1,490.00	\$1,760.00
61" x 22" DBL30 (LR-15.5)	\$1,470.00	\$1,600.00	\$1,800.00	\$2,070.00
61" x 22" DBL36 (LR-12.5)	\$1,470.00	\$1,600.00	\$1,800.00	\$2,070.00
73" x 22" DBL36 (LR-18.5)	\$1,640.00	\$1,800.00	\$2,030.00	\$2,350.00
73" x 22" DBL42 (LR-15.5)	\$1,640.00	\$1,800.00	\$2,030.00	\$2,350.00
19" or 22" Endsplash	\$80.00	\$95.00	\$120.00	\$140.00

PRISM QUARTZ VANITY TOPS

2CM CUSTOM LIST PRICING

MULTIPLIER

All depths indicated are 19¼" or 22¼".

INCLUDES:

- 4" Loose Backsplash
- Bowl Not Included (See Pricing Below)
- Eased Front Edge Only

PRISM QUARTZ BY RYNONE				
	GROUP 1	GROUP 2	GROUP 3	GROUP 4
	Q-1002 Ocean Gray Q-3001 Polar White Q-3007 Porcelain White Q-3010 Iceberg	Q-3009 Carrara Verta Q-3012 Terra Gray Q-3016 Miami Ora	Q-3006 Gray Pearl Q-3011 Stormy Gray Q-3017 Calacatta Premata	Q-3013 Copper Sand Q-3003 White Pearl
Up to 25" x 19" or 22"	\$350.00	\$410.00	\$480.00	\$600.00
Up to 31" x 19" or 22"	\$440.00	\$500.00	\$600.00	\$740.00
Up to 37" x 19" or 22"	\$520.00	\$600.00	\$710.00	\$880.00
Up to 43" x 19" or 22"	\$600.00	\$700.00	\$830.00	\$1,020.00
Up to 49" x 19" or 22"	\$690.00	\$790.00	\$940.00	\$1,160.00
Up to 55" x 19" or 22"	\$770.00	\$890.00	\$1,060.00	\$1,310.00
Up to 61" x 19" or 22"	\$850.00	\$980.00	\$1,180.00	\$1,450.00
Up to 67" x 19" or 22"	\$930.00	\$1,080.00	\$1,290.00	\$1,590.00
Up to 73" x 19" or 22"	\$1,020.00	\$1,180.00	\$1,410.00	\$1,730.00
Up to 79" x 19" or 22"	\$1,100.00	\$1,270.00	\$1,520.00	\$1,870.00
Up to 85" x 19" or 22"	\$1,180.00	\$1,370.00	\$1,640.00	\$2,020.00
Up to 91" x 19" or 22"	\$1,270.00	\$1,470.00	\$1,750.00	\$2,160.00
Up to 97" x 19" or 22"	\$1,350.00	\$1,560.00	\$1,870.00	\$2,300.00
Up to 103" x 19" or 22"	\$1,430.00	\$1,660.00	\$1,980.00	\$2,440.00
Up to 109" x 19" or 22"	\$1,520.00	\$1,760.00	\$2,100.00	\$2,580.00
Up to 115" x 19" or 22"	\$1,600.00	\$1,850.00	\$2,210.00	\$2,730.00
Up to 120" x 19" or 22"	\$1,680.00	\$1,940.00	\$2,320.00	\$2,880.00
4" Splash Material \$/inch	\$4.00	\$4.50	\$5.25	\$6.00

STANDARD CUTOUTS & UNDERMOUNT BOWLS INSTALLED	
Porcelain Oval Bowl Installed (White, Biscuit or Black)	\$310.00
Porcelain Rectangular Bowl Installed (White or Biscuit)	\$310.00
Oval Bowl Installed (Stainless Steel)	\$455.00
STANDARD FINISHED ENDS (19", 22", 25")	
Cut Edge (Unfinished)	No Charge
Finished Flat OR Eased Finished Edge (Polished)	\$80.00
UPGRADE PROFILE OPTIONS (OGEE, BEVEL, BULLNOSE OR DEMI-BULLNOSE)	
Upgrade Profiled Finished End (19", 22", 25")	\$100.00
Upgrade Profiled Oval Cutout	\$450.00
Upgrade Profiled Rectangular Cutout	\$490.00
Upgrade Profiled Front Edge Cost/Lin In	\$4.00
UPCHARGE	
Up to 25¼" Deep with 4" Backsplash	20%

OPTIONS AND ADD-ONS AVAILABLE BY QUOTE ONLY
<ul style="list-style-type: none"> • Wing Over & Cut Backs (Banjo Top) • Clipped Corner • Radius Corner • Full Radius • Angle Cut • Machined Edges (Profiled or Eased) • Custom Cutout (Template Required) • Customer-Supplied Bowl Installed • Non-Standard Depths • Bump-Out (Variable Depth) • Special Shapes and Angles
Special Applications Available for Quote (ex., Sills, Pass-throughs, Thresholds, etc.)

****For stability, tops OVER 61" must ship with installed bowl(s).**

GRANITE VANITY TOPS

UNIQUE. EXQUISITE. TIMELESS.



Rynone Granite Vanity Tops are manufactured from the finest granite available. Granite is an ultra-tough solid surface with color and pattern running throughout the stone for a striking appearance. It requires only simple care to remain beautiful, functional and stylish for years to come. It's an investment in beauty you'll be happy you made.

PERFECT FOR

- Home Bathrooms
- Multi-Unit Residences
- Hospitality Facilities
- Any Upscale Vanity

OPTIONS

- 12 Colors
- 2cm and 3cm Thickness
- Standard Lengths: 25", 31", 37", 43", 49", 61" and 73"
- Custom Sizes up to 110" long
- Standard Depths: 19¼" and 22¼"
- Undermount Porcelain Bowls in Oval or Rectangular
- Custom Bowl Cutouts Available
- Standard Eased Edge
- 4 Custom Edge Profiles
- 4" Loose Backsplash

EASY ORDER, QUICK DELIVERY

Just complete the order process with your design consultant, and you can have your beautiful Rynone Granite Vanity Tops in as little as two weeks. Special orders only take a little longer.

GROUP 1 COLORS

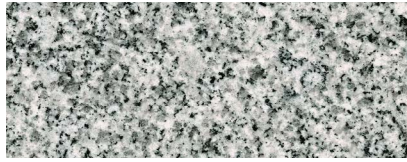
**NEW COS812** New Caledonia**NEW COS811** Majestic White**NEW COS815** White Napoli

GROUP 2 COLORS

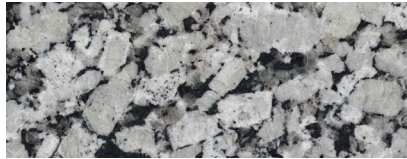
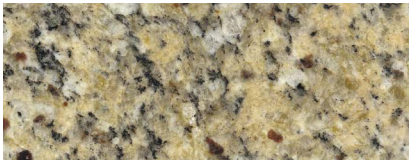
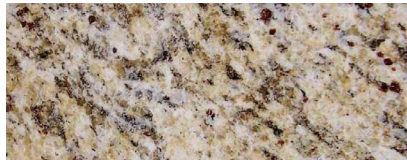
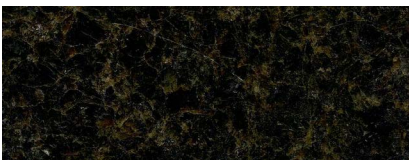
**NEW COS814** Tanami**NEW COS845** Iberian White**NEW COS846** Oro Brasil**NEW COS823** Santa Cecilia Lt**NEW COS844** Crema Pearl**NEW COS822** Blanco Leblon**NEW COS821** Azul Platino**NEW COS843** Blanco Perla**COS813** Ubatuba

EIGHT REASONS TO CHOOSE RYNONE GRANITE VANITY TOPS

- 1 | **Timeless Style** / Enduring, stunning looks that complement any bathroom design.
- 2 | **Natural Beauty** / Each surface uniquely special.
- 3 | **High-End Effect** / Luxurious appearance that makes a statement and enhances home value.
- 4 | **Wide Selection** / Available in an array of beautiful, striking colors and patterns.
- 5 | **Easy Care** / Easy to keep clean and sanitary to avoid bacterial contamination.
- 6 | **Highly Durable** / Hard, long-lasting surface that resists staining and retains its beauty for many years.
- 7 | **Wise Investment** / No one can match the quality, workmanship and value of a Rynone Granite Vanity Top.
- 8 | **Sustainably Made** / Rynone uses eco-friendly processes to manufacture its vanity tops.

GRANITE VANITY TOPS

2CM STANDARD LIST PRICING

MULTIPLIER

All depths indicated are 19¼" or 22¼".

INCLUDES:

- 4" Loose Backsplash
- Porcelain Oval or Rectangular Bowl
- Eased Front & Two Finished Ends

	GRANITE	
	GROUP 1	GROUP 2
	COS811 Majestic White COS812 New Caledonia COS815 White Napoli	COS814 Tanami COS821 Azul Platino COS822 Blanco Leblon COS823 Santa Cecilia Lt COS843 Blanco Perla COS844 Crema Pearl COS845 Iberian White COS846 Oro Brasil COS813 Ubatuba
25" x 19"	\$540.00	\$570.00
31" x 19"	\$580.00	\$620.00
37" x 19"	\$610.00	\$660.00
49" x 19"	\$680.00	\$740.00
25" x 22"	\$540.00	\$570.00
31" x 22"	\$580.00	\$620.00
37" x 22"	\$610.00	\$660.00
43" x 22"	\$640.00	\$700.00
49" x 22"	\$680.00	\$740.00
61" x 22"	\$760.00	\$830.00
61"x 22" DBL30 (LR-15)	\$1,040.00	\$1,120.00
61"x 22" DBL36 (LR-12)	\$1,040.00	\$1,120.00
73"x 22" DBL36 (LR-18)	\$1,110.00	\$1,200.00
73"x 22" DBL42 (LR-15)	\$1,110.00	\$1,200.00
19" or 22" Endsplash	\$60.00	\$75.00

GRANITE VANITY TOPS

MULTIPLIER

2CM CUSTOM LIST PRICING

All depths indicated are 19¼" or 22¼".

INCLUDES:

- 4" Loose Backsplash
- Bowl Not Included (See Pricing Below)
- Eased Front Edge Only

GRANITE		
	GROUP 1	GROUP 2
	COS811 Majestic White COS812 New Caledonia COS815 White Napoli	COS814 Tanami COS821 Azul Platino COS822 Blanco Leblon COS823 Santa Cecilia Lt COS843 Blanco Perla COS844 Crema Pearl COS845 Iberian White COS846 Oro Brasil COS813 Ubatuba
Up to 25" x 22" or 19"	\$270.00	\$330.00
Up to 31" x 22" or 19"	\$330.00	\$400.00
Up to 37" x 22" or 19"	\$390.00	\$470.00
Up to 43" x 22" or 19"	\$450.00	\$540.00
Up to 49" x 22" or 19"	\$510.00	\$610.00
Up to 55" x 22" or 19"	\$590.00	\$710.00
Up to 61" x 22" or 19"	\$650.00	\$780.00
Up to 67" x 22" or 19"	\$720.00	\$860.00
Up to 73" x 22" or 19"	\$770.00	\$930.00
Up to 79" x 22" or 19"	\$840.00	\$1,010.00
Up to 85" x 22" or 19"	\$900.00	\$1,080.00
Up to 91" x 22" or 19"	\$970.00	\$1,160.00
Up to 97" x 22" or 19"	\$1,030.00	\$1,240.00
Up to 103" x 22" or 19"	\$1,090.00	\$1,310.00
Up to 109" x 22" or 19"	\$1,160.00	\$1,390.00
Up to 115" x 22" or 19"	\$1,220.00	\$1,470.00
Up to 120" x 22" or 19"	\$1,270.00	\$1,530.00
4" Splash Material \$/inch	\$4.00	\$6.00

STANDARD CUTOUTS & UNDERMOUNT BOWLS INSTALLED	
Porcelain Oval Bowl Installed (White, Biscuit or Black)	\$439.00
Porcelain Rectangular Bowl Installed (White or Biscuit)	\$439.00
Oval Bowl Installed (Stainless Steel)	\$645.00
STANDARD FINISHED ENDS (19", 22", 25")	
Cut Edge (Unfinished)	No Charge
Finished Flat OR Eased Finished Edge (Polished)	\$113.00
UPGRADE PROFILE OPTIONS (OGEE, BEVEL, BULLNOSE OR DEMI-BULLNOSE)	
Upgrade Profiled Finished End (19", 22", 25")	\$142.00
Upgrade Profiled Oval Cutout	\$638.00
Upgrade Profiled Rectangular Cutout	\$694.00
Upgrade Profiled Front Edge Cost/Lin In	\$6.00
UPCHARGE	
25¼" Deep with 4" Backsplash	20%

OPTIONS AND ADD-ONS AVAILABLE BY QUOTE ONLY

- Wing Over & Cut Backs (Banjo Top)
- Clipped Corner
- Radius Corner
- Full Radius
- Angle Cut
- Machined Edges (Profiled or Eased)
- Custom Cutout (Template Required)
- Customer-Supplied Bowl Installed
- Non-Standard Depths
- Bump-Out (Variable Depth)
- Special Shapes and Angles

Special Applications Available for Quote (ex., Sills, Pass-throughs, Thresholds, etc.)

****For stability, tops OVER 61" must ship with installed bowl(s).**

RYN0425GV2CMCUS

NEW

PRISM QUARTZ SLIMLINE VANITY TOPS

DISTINCTIVE. BEAUTIFUL. CONTEMPORARY.

Now available at Rynone in 1.5cm thickness for a keen slim line appearance. Scratch, impact, heat, and stain-resistant, and low maintenance with no sealing required.

All the benefits of Quartz in a thinner and lighter size. Rated for commercial and residential applications.

INTRODUCING 1.5CM QUARTZ VANITIES

Quartz surfacing has five times the flexural strength of natural granite. A 1.5cm Quartz vanity top is stronger than a 3cm granite top.

OPTIONS

- 6 Colors
- 1.5cm Thickness
- Standard Lengths: 25", 31", 37", 43", 49", 61" and 73"
- Custom Sizes up to 120" long
- Standard Depths: 19¼" and 22¼"
- Undermount Porcelain Bowls in Oval or Rectangular
- Standard Eased Edge
- 4" Loose Backsplash

EASY ORDER, QUICK DELIVERY

Just complete the order process with your design consultant, and you can have your beautiful Prism Quartz SlimLine Vanity Tops in as little as two weeks. Custom orders take less than three weeks.

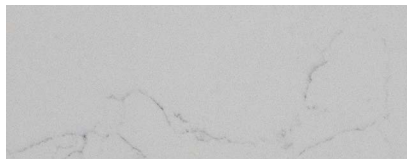

NEW**QS-3010** Iceberg**QS-3052** Carrara Latte**QS-3051** Nevado**QS-3053** Carrara Alpina**QS-3055** Diamond Reef**QS-3054** Carbonite**EIGHT REASONS TO CHOOSE PRISM QUARTZ SLIMLINE VANITY TOPS**

- 1 | **Enduring Style** / Prism Quartz by Rynone vanity tops come in rich colors and classic patterns to create contemporary and timeless designs.
- 2 | **Radiant Beauty** / Prism Quartz by Rynone makes for beautiful, natural-looking vanity tops that enhance the appearance of any home.
- 3 | **Highly Durable** / Rynone uses a nonporous quartz surface material that is heat, scratch and stain resistant. Because it is also mold and mildew resistant, sealers are unnecessary.
- 4 | **Easy Care** / Prism Quartz by Rynone can usually be cleaned with soap and water.
- 5 | **Superior Quality** / Prism Quartz Vanity Tops are tough, resilient and can last a lifetime. That's a sound home investment.
- 6 | **Fast Delivery** / A huge stock of Prism Quartz Vanity Tops is ready to ship in as little as two weeks. Custom orders take less than three weeks.
- 7 | **Sustainably Made** / Rynone uses eco-friendly processes to manufacture its vanity tops.
- 8 | **Trusted Source** / Rynone has the capabilities, resources and commitment to deliver what we promise.



NEW

PRISM QUARTZ SLIMLINE VANITY TOPS

MULTIPLIER

1.5CM STANDARD LIST PRICING

All depths indicated are 19¼" or 22¼".

INCLUDES:

- 4" Loose Backsplash
- Porcelain Oval or Rectangular Bowl
- Eased Front & Two Finished Ends

PRISM QUARTZ BY RYNONE		
	GROUP 1	GROUP 2
	QS-3010 Iceberg	QS-3054 Carbonite QS-3053 Carrara Alpina QS-3052 Carrara Latte QS-3055 Diamond Reef QS-3051 Nevado
25" x 19"	\$500.00	\$540.00
31" x 19"	\$560.00	\$600.00
37" x 19"	\$620.00	\$660.00
49" x 19"	\$780.00	\$860.00
25" x 22"	\$530.00	\$570.00
31" x 22"	\$600.00	\$640.00
37" x 22"	\$660.00	\$710.00
43" x 22"	\$720.00	\$780.00
49" x 22"	\$780.00	\$860.00
61" x 22"	\$910.00	\$1,000.00
61" x 22" DBL30 (LR-15.5)	\$1,340.00	\$1,430.00
61" x 22" DBL36 (LR-12.5)	\$1,340.00	\$1,430.00
73" x 22" DBL36 (LR-18.5)	\$1,460.00	\$1,570.00
73" x 22" DBL42 (LR-15.5)	\$1,460.00	\$1,570.00
19" or 22" Endsplash	\$80.00	\$95.00



NEW

PRISM QUARTZ SLIMLINE VANITY TOPS

MULTIPLIER

1.5CM CUSTOM LIST PRICING

All depths indicated are 19¼" or 22¼".

INCLUDES:

- 4" Loose Backsplash
- Bowl Not Included (See Pricing Below)
- Eased Front Edge Only

	PRISM QUARTZ BY RYNONE	
	GROUP 1	GROUP 2
	QS-3010 Iceberg	QS-3054 Carbonite QS-3053 Carrara Alpina QS-3052 Carrara Latte QS-3055 Diamond Reef QS-3051 Nevada
Up to 25" x 19" or 22"	\$270.00	\$300.00
Up to 31" x 19" or 22"	\$330.00	\$380.00
Up to 37" x 19" or 22"	\$390.00	\$450.00
Up to 43" x 19" or 22"	\$460.00	\$520.00
Up to 49" x 19" or 22"	\$520.00	\$590.00
Up to 55" x 19" or 22"	\$580.00	\$660.00
Up to 61" x 19" or 22"	\$650.00	\$730.00
Up to 67" x 19" or 22"	\$710.00	\$810.00
Up to 73" x 19" or 22"	\$770.00	\$880.00
Up to 79" x 19" or 22"	\$830.00	\$950.00
Up to 85" x 19" or 22"	\$900.00	\$1,020.00
Up to 91" x 19" or 22"	\$960.00	\$1,090.00
Up to 97" x 19" or 22"	\$1,020.00	\$1,160.00
Up to 103" x 19" or 22"	\$1,090.00	\$1,240.00
Up to 109" x 19" or 22"	\$1,150.00	\$1,310.00
Up to 115" x 19" or 22"	\$1,210.00	\$1,380.00
Up to 120" x 19" or 22"	\$1,260.00	\$1,440.00
4" Splash Material \$/inch	\$4.00	\$4.50

STANDARD CUTOUTS & UNDERMOUNT BOWLS INSTALLED	
Porcelain Oval Bowl Installed (White, Biscuit or Black)	\$310.00
Porcelain Rectangular Bowl Installed (White or Biscuit)	\$310.00
STANDARD FINISHED ENDS (19", 22", 25")	
Cut Edge (Unfinished)	No Charge
Flat OR Eased Finished End (Polished)	\$80.00
UPCHARGE	
Up to 25¼" Deep with 4" Backsplash	25%

****For stability, tops OVER 61" must ship with installed bowl(s).**

OPTIONS AND ADD-ONS AVAILABLE BY QUOTE ONLY
<ul style="list-style-type: none"> • Wing Over & Cut Backs (Banjo Top) • Clipped Corner • Radius Corner • Full Radius • Angle Cut • Machined Edges (Profiled or Eased) • Custom Cutout (Template Required) • Customer-Supplied Bowl Installed • Non-Standard Depths • Bump-Out (Variable Depth) • Special Shapes and Angles
Special Applications Available for Quote (ex., Sills, Pass-throughs, Thresholds, etc.)

STONE EDGE PROFILES



2CM / Eased



3CM / Eased



2CM / Bevel



3CM / Bevel



2CM / Ogee



3CM / Ogee



2CM / Bullnose



3CM / Bullnose



2CM / Demi-Bullnose



3CM / Demi-Bullnose

VANITY TOP BOWLS

STANDARD UNDERMOUNT FOR GRANITE AND QUARTZ

SMALL PORCELAIN OVAL UNDERMOUNT BOWLS



OVERALL SIZE			INTERIOR SIZE		
Length	Width	Depth	Length	Width	Depth
17"	14"	7½"	15"	12"	6"

LARGE PORCELAIN OVAL UNDERMOUNT BOWLS

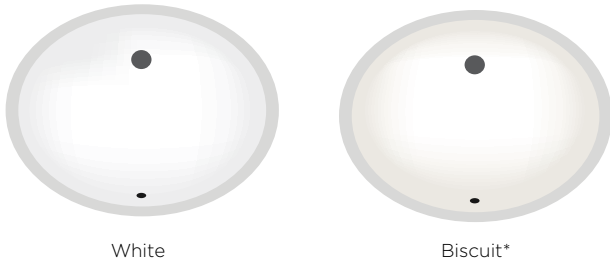

OVERALL SIZE			INTERIOR SIZE		
Length	Width	Depth	Length	Width	Depth
19¼"	15¾"	8"	17¼"	14"	6¼"

PORCELAIN RECTANGULAR UNDERMOUNT BOWLS



OVERALL SIZE			INTERIOR SIZE		
Length	Width	Depth	Length	Width	Depth
20"	15"	7½"	18"	13"	6"

STANDARD BOWL PLACEMENT

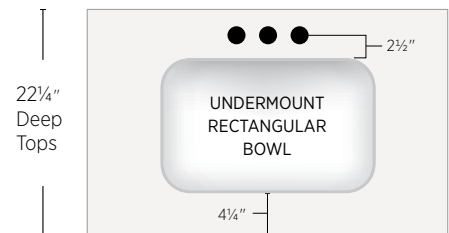
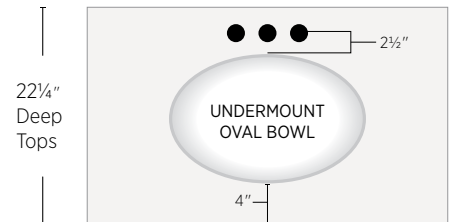
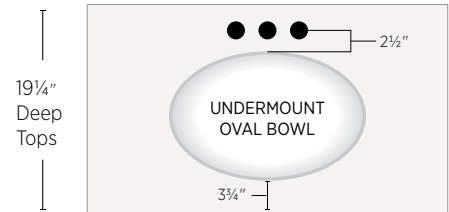

*Dimensions are +/- 1/8".

*Diameter of all faucet holes is 1 3/8".

*Sink cutouts are polished.

The printing on this page may not accurately represent the slight color variations.

CULTURED MARBLE VANITY TOPS

CLASSIC. BEAUTIFUL. AFFORDABLE.



Creating beautiful designs for your bathroom projects is easy with Rynone Cultured Marble Vanity Tops. Available in an array of colors and patterns, they give you the custom look you want. This tough, resilient surface is ideal for projects that demand stylish durability. It's also surprisingly affordable compared to other options.

PERFECT FOR

- Residential Bathrooms
- Multi-Unit Residences
- Hospitality & Institutional
- Offices & Commercial

OPTIONS

- 12 Colors
- Available In Gloss or Satin Finish
- Standard Depths: 19", 22", Plus 19" X 17"
- Custom Sizes up to 144"
- 5 Integral Bowl Options
- Standard Eased Edge
- Loose Or Integral Backsplash
- Aprons, Notches and Cutouts
- ADA-Compliant Bowls Available

EASY ORDER, QUICK DELIVERY

Just complete the order process with your design consultant, and you can have your cultured marble vanity tops in as little as five days. Special orders only take a little longer.



All Colors Available in Satin Finish and Gloss

GROUP 1 COLORS



3B Solid White

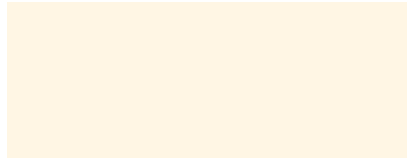

1B Solid Biscuit



3 White on White

GROUP 2 COLORS

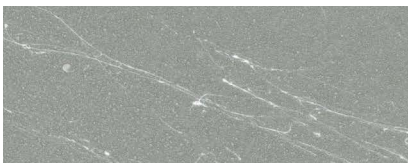

C100 Agate



C102 Ash

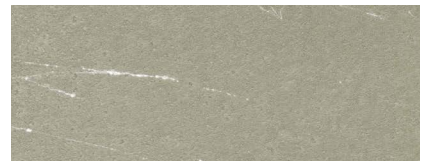

C106 Pearl



C105 Pewter



1C Biscuit Carrara

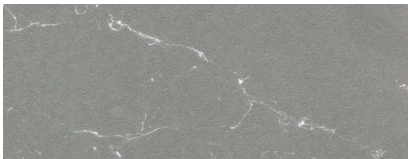

4C Flint



18C Sandstone Carrara

NEW WHY CHOOSE RYNONE SATIN FINISH

- A Satin finish is inviting to the touch and less prone to glare. It creates a softer look than the Gloss finish. Colors are slightly subdued, like sea glass on a beach.
- Satin finishes look great in rooms with lots of natural light. The softer reflection creates a gentler aesthetic and ambience.
- A Satin finish can be more forgiving between cleanings. Minor topical conditions such as water spots and fingerprints are less conspicuous.
- Any accidental damage, like a scratch or scuff marks in a high-traffic area, would be less noticeable with the Satin finish.
- Start with beautiful Rynone cultured marble colors, then choose either a Gloss finish for a vibrant color saturation and contrast or the new Satin finish for a sophisticated and subtle option.

GROUP 3 COLORS

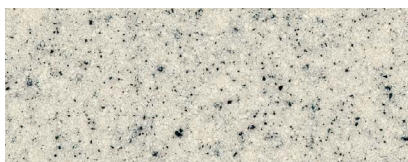

331 Fashion Gray



332 Ecru

Viewing colors on screen or in print may change appearance. These images are as close as possible to actual colors, and are meant to represent colors and patterns that do have variation. Abstract vein patterns are unique by design. Each patterned marble top is one of a kind.



CULTURED MARBLE VANITY TOPS

STANDARD LIST PRICING

MULTIPLIER

BOWL AVAILABILITY					STANDARD SIZES INCLUDE: • 4" Integral Backsplash • Integral Bowl • Two Finished Ends • Choice of Satin or Gloss Finish	STANDARD INTEGRAL BOWL		
OVAL	RCO	WAVE	RECT	RSQ		GROUP 1	GROUP 2	GROUP 3
See Corner Sheet				Custom		25" Corner Sink	\$175.00	\$210.00
					SLIM DEPTH			
•				Custom	19" x 17" Micro Center Bowl**	\$85.00	\$110.00	\$130.00
•					19" x 17" Mini Center Bowl***	\$100.00	\$120.00	\$150.00
•	•				25" x 19" Center Bowl	\$126.00	\$160.00	\$190.00
•	•				31" x 19" Center Bowl	\$143.00	\$180.00	\$220.00
•	•				37" x 19" Center Bowl	\$163.00	\$200.00	\$250.00
	•				43" x 19" Center Bowl	\$187.00	\$230.00	\$290.00
•	•				49" x 19" Center Bowl	\$210.00	\$260.00	\$320.00
					STANDARD DEPTH (22")			
•	•			Custom	25" x 22" Center Bowl	\$133.00	\$160.00	\$200.00
	•				28" x 22" Center Bowl	\$150.00	\$180.00	\$230.00
•	•				31" x 22" Center Bowl	\$150.00	\$180.00	\$230.00
	•				34" x 22" Center Bowl	\$170.00	\$210.00	\$260.00
•	•				37" x 22" Center Bowl	\$170.00	\$210.00	\$260.00
•	•				43" x 22" Center Bowl	\$193.00	\$240.00	\$290.00
•	•				49" x 22" Center Bowl	\$220.00	\$270.00	\$330.00
•	•			61" x 22" Center Bowl	\$273.00	\$330.00	\$410.00	
					STANDARD DOUBLE BOWLS AND OFFSETS			
•	•			Custom	49" x 22" DBL24 (LR-12.5)	\$330.00	\$400.00	\$500.00
•	•				61" x 22" Offset 15.5	\$283.00	\$340.00	\$430.00
•	•				61" x 22" DBL30 (LR-15.5)	\$383.00	\$460.00	\$580.00
•	•				61" x 22" DBL36 (LR-12.5)	\$383.00	\$460.00	\$580.00
•	•				73" x 22" DBL36 (LR-18.5)	\$458.00	\$550.00	\$690.00
•	•				73" x 22" DBL42 (LR-15.5)	\$458.00	\$550.00	\$690.00
•	•				73" x 22" DBL48 (LR-12.5)	\$458.00	\$550.00	\$690.00
•	•				85" x 22" DBL36 (LR-24.5)	\$540.00	\$650.00	\$810.00
•	•				85" x 22" DBL42 (LR-21.5)	\$540.00	\$650.00	\$810.00
•	•				85" x 22" DBL48 (LR-18.5)	\$540.00	\$650.00	\$810.00
•	•				85" x 22" DBL54 (LR-15.5)	\$540.00	\$650.00	\$810.00
•	•				85" x 22" DBL61 (LR-12.5)	\$540.00	\$650.00	\$810.00
					ENDSPLASHES			
17" Micro, 17" Mini, 19" or 22"						\$18.00	\$21.60	\$27.00

**1917 Micro = 18½" x 16½" deep, with 2¼" splash, no 8" drilling
 ***1917 Mini = 19" x 17" deep with 2⅞" splash, no 8" drilling

MULTIPLIER

CULTURED MARBLE VANITY TOPS

CUSTOM LIST PRICING

CUSTOM SIZES INCLUDE:

- 4" Integral Backsplash
- One Integral Bowl (Options Below)
- Finished Front Edge
- Choice of Satin or Gloss Finish

CULTURED MARBLE		
GROUP 1	GROUP 2	GROUP 3
3B - Solid White 1B - Solid Biscuit 3 - White on White	C100 - Agate C102 - Ash C106 - Pearl C105 - Pewter 1C - Biscuit Carrara 18C - Sandstone Carrara 4C - Flint	331 - Fashion Gray 332 - Ecru

LENGTH	DEPTH			
Up to 24"	17", 19" or 22"	\$133.00	\$160.00	\$200.00
Up to 30"	17", 19" or 22"	\$150.00	\$180.00	\$230.00
Up to 36"	17", 19" or 22"	\$170.00	\$210.00	\$260.00
Up to 42"	17", 19" or 22"	\$193.00	\$240.00	\$290.00
Up to 48"	17", 19" or 22"	\$220.00	\$270.00	\$330.00
Up to 54"	17", 19" or 22"	\$246.00	\$300.00	\$370.00
Up to 60"	17", 19" or 22"	\$273.00	\$330.00	\$410.00
Up to 66"	17", 19" or 22"	\$310.00	\$380.00	\$470.00
Up to 72"	17", 19" or 22"	\$347.00	\$420.00	\$530.00
Up to 78"	17", 19" or 22"	\$384.00	\$470.00	\$580.00
Up to 84"	17", 19" or 22"	\$421.00	\$510.00	\$640.00
Up to 90"	17", 19" or 22"	\$458.00	\$550.00	\$690.00
Up to 96"	17", 19" or 22"	\$495.00	\$600.00	\$750.00
Up to 102"	17", 19" or 22"	\$532.00	\$640.00	\$800.00
Up to 108"	17", 19" or 22"	\$569.00	\$690.00	\$860.00
Up to 114"	17", 19" or 22"	\$606.00	\$730.00	\$910.00
Up to 120"	17", 19" or 22"	\$643.00	\$780.00	\$970.00
Up to 126"	22" only	\$680.00	\$820.00	\$1,020.00
Up to 132"	22" only	\$717.00	\$870.00	\$1,080.00
Up to 138"	22" only	\$754.00	\$910.00	\$1,140.00
Up to 144"	22" only	\$791.00	\$950.00	\$1,190.00

INTEGRAL BOWL OPTIONS: RECESSED RECTANGULAR, OVAL, RECESSED OVAL, WAVE OR RECTANGULAR ADA-COMPLIANT BOWLS AVAILABLE - SEE CULTURED MARBLE BOWL OPTIONS

Offset Bowl	\$10.00	\$12.00	\$20.00
Extra Bowl	\$127.00	\$160.00	\$200.00

OPTIONS AND ADD-ONS

Finished End	\$25.00	\$30.00	\$40.00
Wing Over and Cut Back	\$50.00	\$60.00	\$80.00
Radius Corner	\$50.00	\$60.00	\$80.00
Flat Work/Sq In	Quote Only	Quote Only	Quote Only

UPCHARGES

25" Deep With Backsplash	25%	25%	25%
Special Depth (Under 25")	50%	50%	50%
Gloss Finish or Satin Finish	No Charge	No Charge	No Charge
Custom or Template C/O	Quote Only	Quote Only	Quote Only
Special Color	Quote Only	Quote Only	Quote Only

UNDERMOUNT BOWLS INSTALLED

- Porcelain Oval White or Biscuit (Minimum Top Length 19") \$120.00
- Porcelain Oval Black (Minimum Top Length 22") \$120.00
- Porcelain Rectangular White or Biscuit (Minimum Top Length 22") \$155.00
- Stainless Steel Oval (Minimum Top Length 22") \$250.00

RYN0325CMVCUS

CULTURED MARBLE BOWL OPTIONS

“WAVE” BOWL (W)

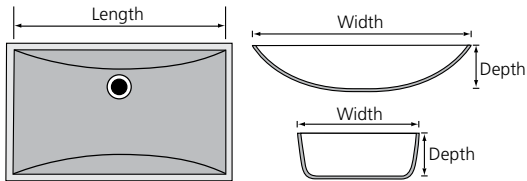

	Bowl Size		
	Length	Width	Depth
22" Top	19¼"	11¾"	5½"
19" Top	17¼"	10"	5¼"

STANDARD OVAL BOWL (O)

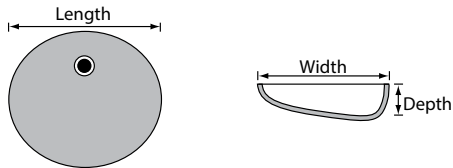

ADA	22" Standard Oval Bowl Available ADA Compliant. When ordering, add "-ADA" at the end of item code.		
	Bowl Size		
	Length	Width	Depth
22" Top	17"	13⅝"	5½"
19" Top	15¼"	11¾"	5⅝"
17" Top	15⅙"	10⅞"	6"

RECTANGULAR BOWL (RECT)

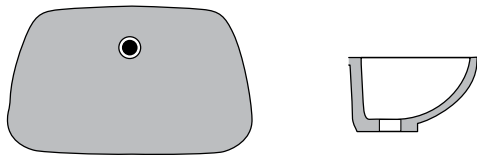

ADA	22" Rectangular Bowl Available ADA Compliant. When ordering, add "-ADA" at the end of item code.		
	Bowl Size		
	Length	Width	Depth
22" Top	17¾"	11"	5¼"
19" Top	17¾"	11"	5¼"

RECESSED OVAL BOWL (RCO)

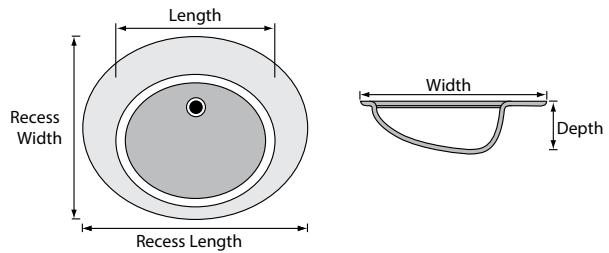

	Bowl Size			Recess Size	
	Length	Width	Depth	Length	Width
22" Top	17⅝"	12⅙"	6"	23"	18¼"
19" Top	15⅝"	10⅝"	6"	21¼"	16⅝"

RECESSED RECTANGULAR BOWL (RSQ)

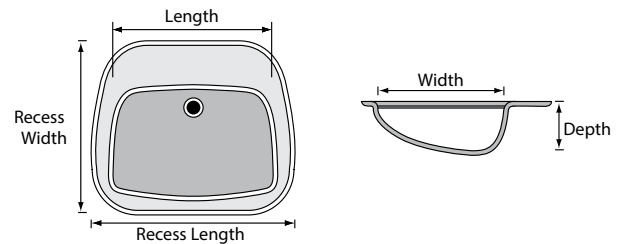

	Bowl Size			Recess Size	
	Length	Width	Depth	Length	Width
22" Top	17¾"	11½"	7⅞"	22½"	18¼"
19" Top	16"	10¼"	7"	19½"	16"

NOTE:

Overall length, width and placement dimensions may vary ¼" to ½".
 All bowls come with an overflow. If you do NOT want an overflow, you must specify.
 Depth measured inside bowl.
 All dimensions are nominal.

CULTURED MARBLE VANITY TOP OPTIONS

CUSTOM OPTIONS

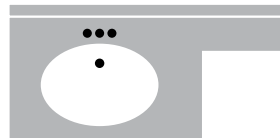

Banjo Tops

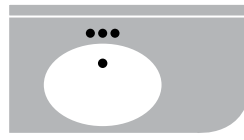

Radius Corners

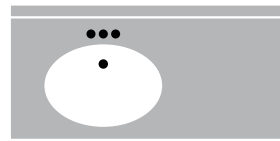

Offset Bowl

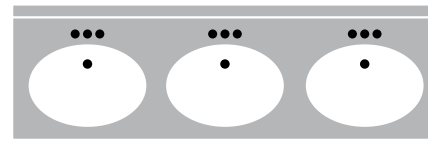

Extra Bowls

CORNER TOPS

Corner tops are also available in spray granite, onyx and color coordinates by special order.

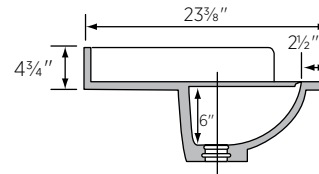
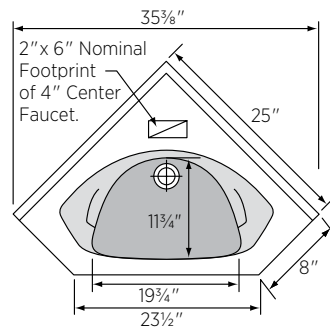

DECK DIMENSIONS

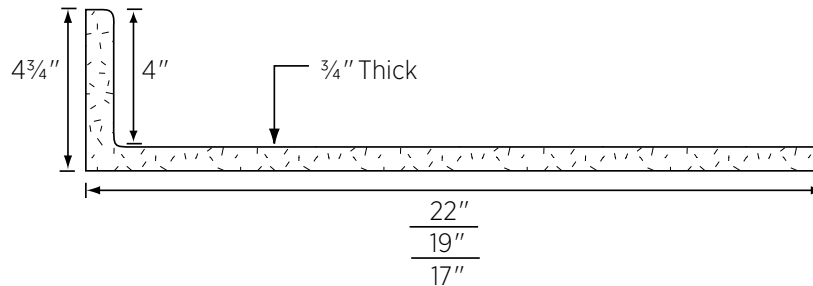

All dimensions are nominal.

1917 Mini = 19" x 17" deep with 2 7/8" splash

1917 Micro = 18 1/2" x 16 1/2" deep, with 2 1/4" splash

SOLID SURFACE VANITY TOPS

VERSATILE. GRACEFUL. PRACTICAL.



Rynone Solid Surface Vanity Tops offer a perfect blend of durable, hard-working practicality and attractive design options that can enhance any restroom. Lasting quality and easy maintenance ensure beauty and function.

PERFECT FOR

- Hospitality & Lodging
- Health Care & Institutional
- Commercial & Public
- Single & Multi-Unit Residences

OPTIONS

- 12 Quick Ship Colors
- Standard 1" Edge with ½" Splash
- Standard Lengths: 25", 28", 31", 34", 37", 43", 49", 61" and 73"
- Custom Sizes up to 144" Long
- Standard Depths: 19¼" and 22¼"
- Integral Oval or Rectangular Bowl
- Custom Bowl Cutouts Available
- 4 Custom Edge Profiles Available
- Optional Integral Cove Backsplash

EASY ORDER, QUICK DELIVERY

Just complete the order process with your design consultant, and you can have your beautiful Rynone Solid Surface Vanity Tops in as little as two weeks. Special orders only take a little longer.



AVONITE
SURFACES

CORIAN®
SOLID SURFACE

FORMICA®

HI-MACS®
Natural Acrylic Stone

staron®
Solid Surfaces

Wilsonart®

RYNONE®

RYN0125SSV.1

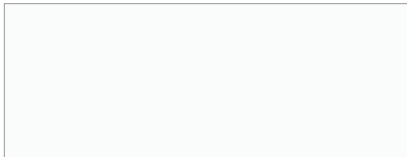

SS-1001 White



M606 Aurora Bianco

HI-MACS
Solid Surface



B012 Oslo White

Hanex
Solid Surfaces



NEW SS-1090 Carrara Lino

CORIAN Solid Surface



SS-8510 Oxbow

AVONITE
SURFACES



SS-8512 Mist

AVONITE
SURFACES



M608 Aurora Gray

HI-MACS
Solid Surface



NEW M603 Pavia

HI-MACS
Solid Surface



NEW CC-009 Cascade Haze

Hanex
Solid Surfaces



SS-7502 Avalanche

AVONITE
SURFACES



SS-4312 Alaskan Stone

AVONITE
SURFACES



SS-4310 Coastline

AVONITE
SURFACES

SEVEN REASONS TO CHOOSE RYNONE SOLID SURFACE VANITY TOPS

- 1 | **Versatile Palette** / A full array of stock and special order colors to fit any space, setting or design preference.
- 2 | **Integrated Surfaces** / Each vanity top can include integral cove backsplash and solid surface bowl.
- 3 | **Graceful Style** / Solid Surface Vanity Tops can achieve the high-end, elegant look that enhances any space.
- 4 | **Stain Resistant** / The nonporous solid surface is stain resistant and keeps spills from permeating the vanity top.
- 5 | **Hygienic Surface** / Ideal for bathrooms and other vanity areas, especially in health care environments and other places where sanitation is important.
- 6 | **Highly Durable** / The color goes all the way through, so it resists wear. Scratches or blemishes can be easily removed, restoring the top to its original beauty.
- 7 | **Easy Care** / The one-piece construction with integrated sinks eliminates seams and grouted joints for easy cleaning.

SOLID SURFACE VANITY TOPS

MULTIPLIER

STANDARD LIST PRICING

INCLUDES:

- 1" Thick Top 19¼" or 22¼"
- ½" x 4" Loose Backsplash
- Porcelain Oval or Rectangular Bowl
- Eased Front & Two Finished Ends
- Satin Finish

PORCELAIN UNDERMOUNT BOWL - WHITE OR BISCUIT

	GROUP 1	GROUP 2	GROUP 3	GROUP 4
	SS-1001 White	NEW CC-009 Cascade Haze SS-8510 Oxbow SS-8512 Mist	SS-4312 Alaskan Stone B012 Oslo White	SS-4310 Coastline SS-7502 Avalanche NEW M603 Pavia M606 Aurora Bianco M608 Aurora Gray NEW SS-1090 Carrara Lino
25" x 19" Center Bowl	\$500.00	\$730.00	\$930.00	\$1,070.00
31" x 19" Center Bowl	\$600.00	\$880.00	\$1,130.00	\$1,300.00
37" x 19" Center Bowl	\$690.00	\$1,030.00	\$1,330.00	\$1,540.00
43" x 19" Center Bowl	\$880.00	\$1,330.00	\$1,730.00	\$2,000.00
49" x 19" Center Bowl	\$880.00	\$1,330.00	\$1,730.00	\$2,000.00
25" x 22" Center Bowl	\$500.00	\$730.00	\$930.00	\$1,070.00
28" x 22" Center Bowl	\$600.00	\$880.00	\$1,130.00	\$1,300.00
31" x 22" Center Bowl	\$600.00	\$880.00	\$1,130.00	\$1,300.00
34" x 22" Center Bowl	\$690.00	\$1,030.00	\$1,330.00	\$1,540.00
37" x 22" Center Bowl	\$690.00	\$1,030.00	\$1,330.00	\$1,540.00
43" x 22" Center Bowl	\$790.00	\$1,180.00	\$1,530.00	\$1,770.00
49" x 22" Center Bowl	\$880.00	\$1,330.00	\$1,730.00	\$2,000.00
61" x 22" Center Bowl	\$1,070.00	\$1,630.00	\$2,130.00	\$2,460.00
61" x 22" DBL30 (LR-15.5)	\$1,170.00	\$1,730.00	\$2,230.00	\$2,560.00
61" x 22" DBL36 (LR-12.5)	\$1,170.00	\$1,730.00	\$2,230.00	\$2,560.00
73" x 22" DBL36 (LR-18.5)	\$1,360.00	\$2,030.00	\$2,630.00	\$3,030.00
73" x 22" DBL42 (LR-15.5)	\$1,360.00	\$2,030.00	\$2,630.00	\$3,030.00
73" x 22" DBL48 (LR-12.5)	\$1,360.00	\$2,030.00	\$2,630.00	\$3,030.00
19" or 22" Endsplash Ea	\$55.00	\$95.00	\$110.00	\$120.00

SOLID SURFACE VANITY TOPS

MULTIPLIER

STANDARD LIST PRICING

INCLUDES:

- 1" Thick Top 19¼" or 22¼"
- ½" x 4" Loose Backsplash
- Eased Front & Two Finished Ends
- Satin Finish
- Includes Integral Solid Surface Oval Bowl(s)

	SOLID SURFACE OVAL INTEGRAL BOWL WHITE OR BISQUE			
	GROUP 1	GROUP 2	GROUP 3	GROUP 4
	SS-1001 White	NEW CC-009 Cascade Haze SS-8510 Oxbow SS-8512 Mist	SS-4312 Alaskan Stone B012 Oslo White	SS-4310 Coastline SS-7502 Avalanche NEW M603 Pavia M606 Aurora Bianco M608 Aurora Gray NEW SS-1090 Carrara Lino
25" x 19" Center Bowl	\$950.00	\$1,180.00	\$1,380.00	\$1,520.00
31" x 19" Center Bowl	\$1,050.00	\$1,330.00	\$1,580.00	\$1,750.00
37" x 19" Center Bowl	\$1,140.00	\$1,480.00	\$1,780.00	\$1,990.00
43" x 19" Center Bowl	\$1,240.00	\$1,630.00	\$1,980.00	\$2,220.00
49" x 19" Center Bowl	\$1,330.00	\$1,780.00	\$2,180.00	\$2,450.00
25" x 22" Center Bowl	\$950.00	\$1,180.00	\$1,380.00	\$1,520.00
28" x 22" Center Bowl	\$1,050.00	\$1,330.00	\$1,580.00	\$1,750.00
31" x 22" Center Bowl	\$1,050.00	\$1,330.00	\$1,580.00	\$1,750.00
34" x 22" Center Bowl	\$1,140.00	\$1,480.00	\$1,780.00	\$1,990.00
37" x 22" Center Bowl	\$1,140.00	\$1,480.00	\$1,780.00	\$1,990.00
43" x 22" Center Bowl	\$1,240.00	\$1,630.00	\$1,980.00	\$2,220.00
49" x 22" Center Bowl	\$1,330.00	\$1,780.00	\$2,180.00	\$2,450.00
61" x 22" Center Bowl	\$1,520.00	\$2,080.00	\$2,580.00	\$2,910.00
61" x 22" DBL30 (LR-15.5)	\$2,070.00	\$2,630.00	\$3,130.00	\$3,460.00
61" x 22" DBL36 (LR-12.5)	\$2,070.00	\$2,630.00	\$3,130.00	\$3,460.00
73" x 22" DBL36 (LR-18.5)	\$2,260.00	\$2,930.00	\$3,530.00	\$3,930.00
73" x 22" DBL42 (LR-15.5)	\$2,260.00	\$2,930.00	\$3,530.00	\$3,930.00
73" x 22" DBL48 (LR-12.5)	\$2,260.00	\$2,930.00	\$3,530.00	\$3,930.00
19" or 22" Endsplash Ea	\$55.00	\$95.00	\$110.00	\$120.00
Rectangle Bowl Upcharge Ea	\$200.00	\$200.00	\$200.00	\$200.00

RYN0325SSVINTEGSTD

SOLID SURFACE VANITY TOPS

CUSTOM LIST PRICING

MULTIPLIER

INCLUDES:

- 1" Thick Top 19¼" or 22¼"
- ½"x 4" Loose Backsplash
- Eased Front Edge Only
- Satin Finish
- Does not include bowl

	SOLID SURFACE			
	GROUP 1	GROUP 2	GROUP 3	GROUP 4
	SS-1001 White	NEW CC-009 Cascade Haze SS-8510 Oxbow SS-8512 Mist	SS-4312 Alaskan Stone B012 Oslo White	SS-4310 Coastline SS-7502 Avalanche NEW M603 Pavia M606 Aurora Bianco M608 Aurora Gray NEW SS-1090 Carrara Lino
Up to 25"	\$400.00	\$630.00	\$830.00	\$970.00
Up to 31"	\$500.00	\$780.00	\$1030.00	\$1,200.00
Up to 37"	\$590.00	\$930.00	\$1,230.00	\$1,440.00
Up to 43"	\$690.00	\$1,080.00	\$1,430.00	\$1,670.00
Up to 49"	\$780.00	\$1,230.00	\$1,630.00	\$1,900.00
Up to 55"	\$880.00	\$1,380.00	\$1,830.00	\$2,130.00
Up to 61"	\$970.00	\$1,530.00	\$2,030.00	\$2,360.00
Up to 67"	\$1,070.00	\$1,680.00	\$2,230.00	\$2,600.00
Up to 73"	\$1,160.00	\$1,830.00	\$2,430.00	\$2,830.00
Up to 79"	\$1,260.00	\$1,980.00	\$2,630.00	\$3,060.00
Up to 85"	\$1,350.00	\$2,130.00	\$2,820.00	\$3,290.00
Up to 91"	\$1,450.00	\$2,280.00	\$3,020.00	\$3,520.00
Up to 97"	\$1,540.00	\$2,430.00	\$3,220.00	\$3,760.00
Up to 103"	\$1,640.00	\$2,580.00	\$3,420.00	\$3,990.00
Up to 109"	\$1,730.00	\$2,730.00	\$3,620.00	\$4,220.00
Up to 115"	\$1,830.00	\$2,880.00	\$3,820.00	\$4,450.00
Up to 121"	\$1,920.00	\$3,030.00	\$4,020.00	\$4,680.00
Up to 127"	\$2,020.00	\$3,180.00	\$4,220.00	\$4,920.00
Up to 133"	\$2,110.00	\$3,330.00	\$4,420.00	\$5,150.00
Up to 139"	\$2,210.00	\$3,480.00	\$4,620.00	\$5,380.00
Up to 144"	\$2,280.00	\$3,600.00	\$4,780.00	\$5,570.00
19" or 22" Endsplash Ea	\$55.00	\$95.00	\$110.00	\$120.00
Extra 4" Splash Per Inch	\$2.70	\$4.70	\$5.70	\$6.70
Finished End Ea	\$25.00	\$50.00	\$60.00	\$70.00

STANDARD CUTOUTS & UNDERMOUNT BOWLS INSTALLED		OPTIONS AND ADD-ONS AVAILABLE BY QUOTE ONLY
Porcelain Oval Undermount Bowl (White or Biscuit)	\$100.00	
Porcelain Rectangular Undermount Bowl (White or Biscuit)	\$120.00	
Solid Surface Oval Integral Bowl (White or Bisque)	\$550.00	
Solid Surface Rectangular Integral Bowl (White or Bisque)	\$750.00	
UPGRADE PROFILE OPTIONS (OGEE, BEVEL, BULLNOSE, OR DEMI-BULLNOSE)		
Upgrade Profiled Finished End (19", 22", 25")	\$100.00	
Upgrade Profiled Oval Cutout	\$450.00	
Upgrade Profiled Rectangular Cutout	\$490.00	
Upgrade Profiled Front Edge Cost/Lin In	\$4.00	
DEPTH UPCHARGE		
25¼" Deep with 4" Backsplash	20%	

BOWL OPTIONS

SOLID SURFACE AND STAINLESS STEEL

SMALL SOLID SURFACE OVAL INTEGRAL BOWL

Overall Size			Interior Size		
Length	Width	Depth	Length	Width	Depth
15 $\frac{7}{8}$ "	12 $\frac{1}{8}$ "	7"	14 $\frac{1}{4}$ "	10 $\frac{5}{16}$ "	5"



White



Bisque*

LARGE SOLID SURFACE OVAL INTEGRAL BOWL

Overall Size			Interior Size		
Length	Width	Depth	Length	Width	Depth
18 $\frac{1}{8}$ "	14 $\frac{3}{4}$ "	7"	16 $\frac{3}{8}$ "	13"	5"



White



Bisque*

SOLID SURFACE RECTANGULAR INTEGRAL BOWL

Overall Size			Interior Size		
Length	Width	Depth	Length	Width	Depth
19 $\frac{1}{2}$ "	14 $\frac{5}{16}$ "	6 $\frac{1}{16}$ "	18"	12 $\frac{3}{4}$ "	5"



White



Bisque*



18-GAUGE STAINLESS STEEL UNDERMOUNT DOUBLE BOWL

32 $\frac{5}{8}$ " x 18 $\frac{1}{4}$ " x 9"



18-GAUGE STAINLESS STEEL UNDERMOUNT SINGLE BOWL

23 $\frac{1}{4}$ " x 17 $\frac{7}{8}$ " x 9"

*The printing on this page may not accurately represent the slight color variations.

SOLID SURFACE CUSTOM TROUGH SINK

CONTEMPORARY. SCALABLE. VERSATILE.

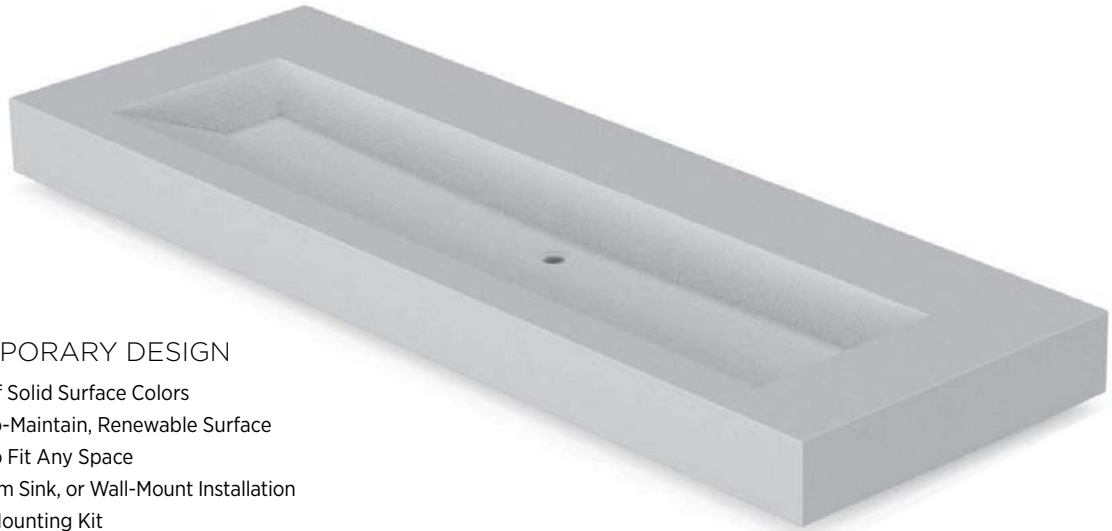

CONTEMPORARY DESIGN

- Full Line of Solid Surface Colors
- An Easy-to-Maintain, Renewable Surface
- Scalable to Fit Any Space
- Vessel, Farm Sink, or Wall-Mount Installation
- Optional Mounting Kit

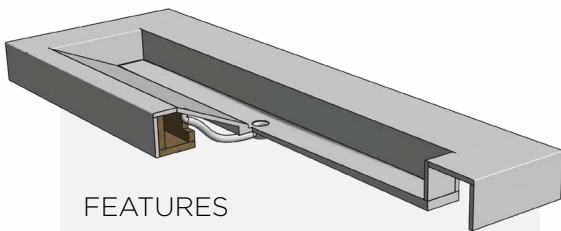

FEATURES

- Finished all 4 Sides
- Optional 4" Loose Backsplash
- Optional Faucet Drilling
- Single Drain to 64", Double to 96", then +1 per 36"
- Choice of any Solid Surface Color
- 1/8" Eased Edge - Matte Finish
- Includes 1/4" Chrome Grid Drain with Overflow
- Standard Depth 22 1/2" - 24"
- ADA-Compliant (When Installed To Guidelines)
- Custom Length as Desired

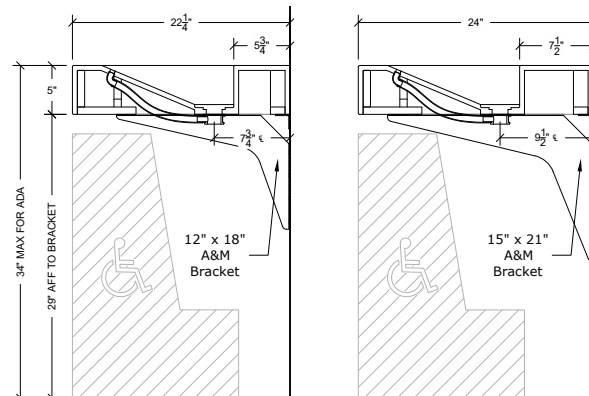
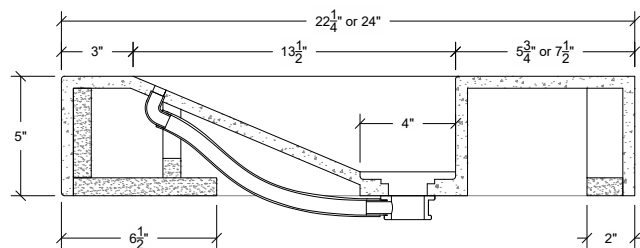

SOLID SURFACE CUSTOM TROUGH SINK

CUSTOM LIST PRICING

MULTIPLIER

INCLUDES:

- ½" Solid Surface
22¼" or 24"
- Matte Finish
- 5" Finished All 4 Sides
- Std Faucet Drilling
- No Hole Faucet, 1 Hole,
3 Hole 4", 3 Hole 8"
- Eased Edge Profile
- Integral Overflow
Tube Chrome Grid
- 1¼" Drain Tailpiece

CUSTOM TROUGH SINK COLORS

	GROUP 1	GROUP 2	GROUP 3	GROUP 4	MOUNTING KIT
	SS-1001 White	NEW CC-009 Cascade Haze SS-8510 Oxbow SS-8512 Mist	SS-4312 Alaskan Stone B012 Oslo White	SS-4310 Coastline SS-7502 Avalanche NEW M603 Pavia M606 Aurora Bianco M608 Aurora Gray NEW SS-1090 Carrara Lino	INCLUDES: Black A&M Brackets; One for Every 24" of Length 'A' Plus One, and Cut-To-Sink-Size Aluminum Wall Cleat
LENGTH					
25	\$2,126.00	\$2,750.00	\$2,910.00	\$3,160.00	\$490.00
31	\$2,749.00	\$3,580.00	\$3,900.00	\$4,350.00	\$490.00
37	\$2,985.00	\$3,800.00	\$4,120.00	\$4,580.00	\$490.00
43	\$3,221.00	\$4,020.00	\$4,340.00	\$4,820.00	\$490.00
49	\$3,457.00	\$4,320.00	\$4,640.00	\$5,130.00	\$570.00
55	\$3,694.00	\$4,540.00	\$4,860.00	\$5,360.00	\$570.00
61	\$3,930.00	\$4,760.00	\$5,080.00	\$5,600.00	\$570.00
67	\$4,717.00	\$5,750.00	\$6,230.00	\$6,940.00	\$570.00
73	\$4,953.00	\$5,970.00	\$6,450.00	\$7,170.00	\$570.00
79	\$5,189.00	\$6,270.00	\$6,750.00	\$7,480.00	\$640.00
85	\$5,784.00	\$7,070.00	\$7,710.00	\$8,640.00	\$640.00
91	\$6,020.00	\$7,290.00	\$7,930.00	\$8,870.00	\$640.00
97	\$6,420.00	\$7,670.00	\$8,310.00	\$9,270.00	\$720.00
103	\$6,656.00	\$7,970.00	\$8,600.00	\$9,580.00	\$720.00
109	\$6,892.00	\$8,190.00	\$8,820.00	\$9,810.00	\$720.00
115	\$7,128.00	\$8,410.00	\$9,050.00	\$10,050.00	\$720.00
121	\$7,364.00	\$8,630.00	\$9,270.00	\$10,280.00	\$800.00
127	\$7,601.00	\$8,930.00	\$9,560.00	\$10,590.00	\$800.00
133	\$8,000.00	\$9,300.00	\$9,940.00	\$10,980.00	\$800.00
139	\$8,237.00	\$9,520.00	\$10,160.00	\$11,220.00	\$800.00
144	\$8,410.00	\$9,680.00	\$10,320.00	\$11,390.00	\$800.00
Add 4" Splash Per Inch	\$2.00	\$3.75	\$4.25	\$5.00	
Tops are Individually Boxed on Pallets					
Any Solid Surface Brand, Any Color, and Over 144" Available by Quote					

RYN0125SSTROUGH.4

BUTCHERBLOCK TOPS

CENTERPOINTE™ REAL WOOD COUNTERTOPS



2 WOOD OFFERINGS: ACACIA AND HEVEA

2 SIDES:

Side "A" is Muted Grain and Color Variation

Side "B" is Bold Grain and Color Variation

Available Unfinished or Oil Finish



ACACIA Side "A" Muted



ACACIA Side "B" Bold



HEVEA Side "A" Muted



HEVEA Side "B" Bold

BUTCHERBLOCK TOPS

CUSTOM LIST PRICING

MULTIPLIER

- 2 Wood Offerings: Hevea and Acacia
- 2 Sides: Side "A" is Muted Grain and Color Variation
Side "B" is Bold Grain and Color Variation
- Available Unfinished, or with an Oil Finish (At No Additional Cost)

BUTCHERBLOCK CENTERPOINTE™ TOPS

WIDTH X LENGTH X THICKNESS	LIST PRICE	
	HEVEA UNFINISHED	ACACIA UNFINISHED
25.5" x 48" x 1½"	\$339.00	\$362.00
25.5" x 96" x 1½"	\$664.00	\$701.00
25.5" x 120" x 1½"	\$944.00	\$1,000.00
39" x 74" x 1½"	\$716.00	\$767.00
Backsplash Size: 4" x 96" x 1½"	\$89.00	\$96.00
ADDITIONAL OPTIONS	LIST PRICE	
90° Miter Joint (Loose with Biscuits and Bolts)	\$233.00	
Field or Butt Joint (Loose with Biscuits and Bolts)	\$200.00	
Cutout Unfinished (Drop-In Sink or Cooktop)	\$233.00	
Cutout Finished (Undermount Sink)	\$333.00	
Cutout U-Shape (Slide-In Range or Farm Sink)	\$266.00	
2-Side Chase Cutout / Notch	\$166.00	
3-Side Chase Cutout / Notch	\$233.00	
Reduce Length of Island or Counter - Each	\$100.00	
Reduce Length of 4" Splash - Each	\$50.00	
Reduce Depth - Per Linear Foot	\$50.00	
Angle Cut / Clip Corner Up to 3"	\$133.00	
Radius Corner Up to 3"	\$250.00	
Full End Radius or Arc End	\$366.00	
UPGRADE EDGE PROFILES - PER LINEAR FOOT		
¾" Bevel, ¾" Radius, ¾" Radius Top & Bottom, Full Bullnose	\$26.00	

LAMINATE COUNTERTOPS



The new generation of laminates rivals other surfaces in look, authenticity and style, while offering a cost-effective option for a variety of applications. Versatility, ease of care, and long-lasting beauty make laminate surfaces practical and economical for virtually any work area.

EIGHT REASONS TO CHOOSE RYNONE LAMINATE COUNTERTOPS

- 1 | **Design Freedom** / Nearly unlimited array of attractive colors and styles.
- 2 | **Budget-Friendly** / Cost-effective way to create beautiful, functional countertops.
- 3 | **Profile Selection** / Self-edge with custom options or popular pre-form edge designs for seamless, no-drip fronts and backsplashes.
- 4 | **Enduring Quality** / Manufactured for heavy use in institutional and commercial settings.
- 5 | **Hygienic Surface** / Nonporous surface to avoid microbe growth.
- 6 | **Low Maintenance** / Easy to clean and virtually maintenance free.
- 7 | **Highly Durable** / Tough, resilient surface that will look great for years under hard use.
- 8 | **Sustainably Made** / Rynone uses eco-friendly processes to manufacture our countertops.



CUSTOM POSTFORM TOPS

- Postform No-Drip
- No-Drip Bar
- Postform Waterfall
- Waterfall Bar
- Postform Euro-Square
- Euro-Square Bar
- Postform Euro-Round
- Euro-Round Bar
- Postform Square-Edge

CUSTOM SELF-EDGE TOPS

- Standard
- Beveled
- Oak Wood



CUSTOM SOLID OAK WOOD EDGES

- Bullnose
- $\frac{3}{8}$ " Waterfall
- $\frac{3}{8}$ " Bevel
- Beaded
- Roman Ogee
- Ogee
- Double $\frac{3}{8}$ " Waterfall

CUSTOM VANITY TOPS

- Self-Edge Vanity Bar/ Flush Apron
- Self-Edge Vanity Bar/ Recessed Apron
- Postform Vanity Bar/ Recessed Apron
- Square Edge-Cove Back Vanity Bar/Recessed Apron



AND MORE...

- Custom End Caps, Miters, Corners, Cutouts
- Custom Self-Edge Splashes
- Custom Self-Edge Flatwork
- Plywood Tops
- Drop-in Sink (Single Bowl or Double Bowl Available) — Shipped Loose or Installed

Ask your design consultant for the popular in-stock Formica® colors for self-edge and post-form no-drip tops available for quick ship. Or choose from hundreds of brand name colors, patterns and textures available as special order.



POSTFORM EDGE PROFILES

TEMPO WATERFALL

One of the most popular choices with a wide variety of applications.



CAPRICE NO-DRIP

No-drip front edge to prevent spills from reaching the floor.

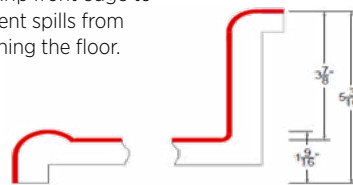

CLASSIC SQUARE

Desirable in both commercial and residential settings.



NOVA EURO ROUND

Ideal for those who prefer a rounded-edge profile design.

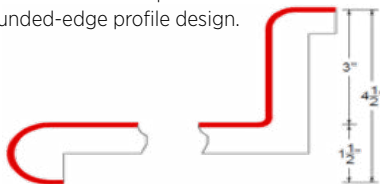

AFTON DOUBLE WATERFALL

Double waterfall ogee blend suitable for any application.

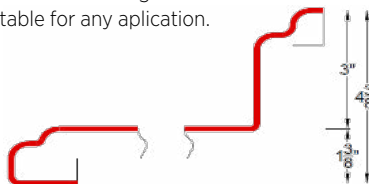

FUTURA EURO SQUARE

Seamless double-radius edge that emulates the "slab" effect.

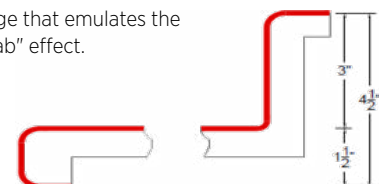

MARBELLA PENCIL

Refined and modern, bringing sophisticated style to every space.

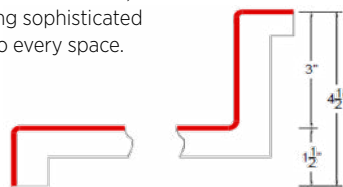

ORA FULL-WRAP PENCIL

Full-wrap pencil-edge design creates a clean and distinctive look.

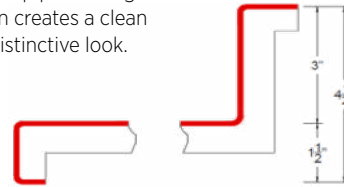

BARCELONA CONTEMPORARY OGEE

Double waterfall edge emulates natural stone and adds distinction and flair.

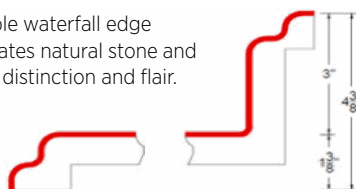

VALENCIA FULL-WRAP OGEE

Dramatic, graceful and contoured are the defining characteristics of this edge profile.

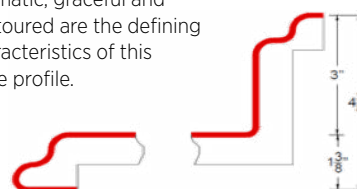

MULTIPLIER

PARTICLE CORE POSTFORM TOPS

STANDARD LIST PRICING

PRICING STEPS	
1	Combine All Counters Into 8' or 10' or 12' Blanks Add up the Linear Foot (must be in 8', 10' and 12' increments)
2	Add any Additional Options
3	Multiply Laminate Items by the Laminate Upgrade Multiplier

- Any Regular Formica Color
- Particle Core
- Kitchen/Vanity & Single Roll

	GROUP 1	GROUP 2	GROUP 3	GROUP 4	
	TEMPO - Waterfall CAPRICE - No Drip	CLASSIC - Square	NOVA - Bullnose FUTURA - Euro	AFTON, MARBELLA, ORA, BARCELONA, VALENCIA	ADD TO INCLUDE BACKER
STEP 1 - BLANKS					
INTEGRAL BACKSPLASH OR NO BACKSPLASH PER LINEAR FOOT					
25 ¼" Kitchen, 19 ¼" or 22 ¼" Vanity	\$26.00	\$27.00	\$28.70	\$32.10	\$8.00
DOUBLE EDGE BAR OR SINGLE EDGE DECK PER LINEAR FOOT					
12" and 15"	\$26.00	\$27.40	\$26.00	\$32.10	\$7.50
18" and 27"	\$27.90	\$29.10	\$30.50	\$32.10	\$8.00
32"	\$43.50	\$44.50	\$42.00	\$58.70	\$10.00
36"	\$45.90	\$47.10	\$44.50	\$59.70	\$10.00
42" or 45"	\$56.00	\$57.60	\$67.50	\$65.10	\$10.00

STEP 2 - ADDITIONAL OPTIONS	
90° Miter Joint (Loose)	\$34.70
90° Miter Joint (Assembled)	\$41.80
Double Miter With Back Shelf	\$156.50
Field Joint (Assembled or Loose)	\$69.80
Cutout - Standard Sink or Range	\$35.10
Cutout - Non-Standard	\$52.30
Cutout- Slide-In Range	\$87.00
Finished End Cap***	\$19.60
Endsplash (Loosed End Mounted)***	\$26.30
Endsplash (Attached End Mounted)***	\$28.40
Partial Endsplash (Attached With Cap)***	\$41.80
Top Mounted Endsplash (Contoured)***	\$52.30
2-Side Chase	\$87.00
3-Side Chase	\$121.60
Sweep Radius Corner (3" Min)	\$52.30
Full Radius End	\$116.00
Arc Radius End	\$69.80
Clipped Angle Corner	\$52.30
Self Edge 4" Splash (Lin Ft)***	\$11.80

- Please include the following items for Laminate Upgrade Multiplier
*** End Caps ***
*** End Splash ***
- Bottom Backer, Enviro EQ Core, and MDF Core available - call for price.

STEP 3 - LAMINATE UPGRADE MULTIPLIER			
BRAND	COLORS	FINISH CODE	MULTIPLIER
Rynone Valu-Line Formica	Almond 920, Butcherblock 204, Butterum Granite 7732, Elemental Concrete 8830, Ivory Kashmere 6226, Midnight Stone 6280, Mineral Jet 3450, Paloma Polar 6698, White 949, White Ice Granite 9476	58	1
	Regular	43,58	1
Formica	Special	26,34,42,46,90,BH,ML, NG,PG,PX,SP,WR	1.1
	Ultra	PA,180FX (any Finish)	1.5
	By Quote	MC	Call
Wilsonart	Regular	38,60	1
	Special	1,12,15,16,18,19,21,22,28,5,52,7,78,79	1.1
	Ultra	35,55,57,67	1.5
Pionite	By Quote	Any 'Y' or 'HD' color	Call
	Regular	SD,VE	1
	Special	GL,AW,CR,GR,LR,LZ,MG,PV,SM, SX,AB,FL,GV,SL,TL,TW	1.1
Nevamar	Ultra	EV	1.2
	By Quote	AS,WE,BB,HX,IW,MZ,NS,NW	Call
	Regular	SD,T,VE	1
Arborite	Special	GL,AW,CR,GR,LR,LZ,MG,PV,SM, SX,AB,FL,GV,SL,TL,TW	1.1
	Ultra	EV	1.2
	By Quote	AS,WE,BB,HX,IW,MZ,NS,NW	Call
Arborite	Regular	SD,T,VE	1
	Special	CA,FP,LE,RM,SR,UM	1.2
	Ultra	CW,IM,VL	1.3

All finish codes available in self-edge & casework.
All finish codes may not be available in postform.

MULTIPLIER

PLYWOOD POSTFORM TOPS

STANDARD LIST PRICING

- Any Regular Formica Color
- Plywood Core
- Kitchen/Vanity & Single Roll

PRICING STEPS	
1	Combine All Counters Into 8' or 10' or 12' Blanks Add up the Linear Foot (must be in 8', 10' and 12' increments)
2	Add any Additional Options
3	Multiply Laminate Items by the Laminate Upgrade Multiplier

STEP 1 - BLANKS	GROUP 1	GROUP 2	GROUP 3	ADD TO INCLUDE BACKER
	TEMPO - Waterfall CAPRICE - No Drip	CLASSIC - Square	NOVA - Bullnose FUTURA - Euro	
INTEGRAL BACKSPLASH OR NO BACKSPLASH PER LINEAR FOOT				
25 1/4" Kitchen, 19 1/4" or 22 1/4" Vanity	\$49.80	\$51.00	\$52.70	\$8.00
DOUBLE EDGE BAR OR SINGLE EDGE DECK PER LINEAR FOOT				
12" and 15"	\$49.80	\$51.40	\$49.80	\$7.50
18" and 27"	\$51.90	\$52.90	\$54.50	\$8.00
32"	\$67.30	\$68.50	\$66.00	\$10.00
36"	\$100.60	\$101.80	\$99.30	\$10.00
42" or 45"	\$110.70	\$112.30	\$122.00	\$10.00

STEP 2 - ADDITIONAL OPTIONS	
90° Miter Joint (Loose)	\$34.70
90° Miter Joint (Assembled)	\$41.80
Double Miter With Back Shelf	\$156.50
Field Joint (Assembled or Loose)	\$69.80
Cutout - Standard Sink or Range	\$35.10
Cutout - Non-Standard	\$52.30
Cutout- Slide-In Range	\$87.00
Finished End Cap***	\$19.60
Endsplash (Loosed End Mounted)***	\$26.30
Endsplash (Attached End Mounted)***	\$28.40
Partial Endsplash (Attached With Cap)***	\$41.80
Top Mounted Endsplash (Contoured)***	\$52.30
2-Side Chase	\$87.00
3-Side Chase	\$121.60
Sweep Radius Corner (3" Min)	\$52.30
Full Radius End	\$116.00
Arc Radius End	\$69.80
Clipped Angle Corner	\$52.30
Self Edge 4" Splash (Lin Ft)***	\$24.90

- Please include the following items for Laminate Upgrade Multiplier
- *** End Caps ***
- *** End Splash ***
- Bottom Backer, Enviro EQ Core, and MDF Core available - call for price.

STEP 3 - LAMINATE UPGRADE MULTIPLIER			
BRAND	COLORS	FINISH CODE	MULTIPLIER
Rynone Valu-Line Formica	Almond 920, Butcherblock 204, Butterum Granite 7732, Elemental Concrete 8830, Ivory Kashmir 6226, Midnight Stone 6280, Mineral Jet 3450, Paloma Polar 6698, White 949, White Ice Granite 9476	58	1
	Regular	43,58	1
	Special	26,34,42,46,90,BH,ML,NG,PG,PX,SP,WR	1.1
	Ultra	PA,180FX (any Finish)	1.5
Formica	By Quote	MC	Call
	Regular	38,60	1
	Special	1,12,15,16,18,19,21,22,28,5,52,7,78,79	1.1
	Ultra	35,55,57,67	1.5
Wilsonart	By Quote	Any 'Y' or 'HD' color	Call
	Regular	SD,VE	1
	Special	GL,AW,CR,GR,LR,LZ,MG,PV,SM,SX,AB,FL,GV,SL,TL,TW	1.1
	Ultra	EV	1.2
Pionite	By Quote	AS,WE,BB,HX,IW,MZ,NS,NW	Call
	Regular	SD,T,VE	1
	Special	GL,AW,CR,GR,LR,LZ,MG,PV,SM,SX,AB,FL,GV,SL,TL,TW	1.1
	Ultra	EV	1.2
Nevamar	By Quote	AS,WE,BB,HX,IW,MZ,NS,NW	Call
	Regular	SD,T,VE	1
	Special	GL,AW,CR,GR,LR,LZ,MG,PV,SM,SX,AB,FL,GV,SL,TL,TW	1.1
	Ultra	EV	1.2
Arborite	By Quote	AS,WE,BB,HX,IW,MZ,NS,NW	Call
	Regular	SD,T,VE	1
	Special	CA,FP,LE,RM,SR,UM	1.2
	Ultra	CW,IM,VL	1.3

All finish codes available in self-edge & casework.
All finish codes may not be available in postform.

RYNO325PFPLY

CUSTOM LAMINATE TOPS

STANDARD LIST PRICING

MULTIPLIER

PRICING STEPS

- 1 Calculate and Combine All Tops and Splash by Sq Ft and/or Lin Ft
- 2 Add Any Additional Options
- 3 Multiply Pricing Base on Laminate Color Upgrade Multiplier

- Base Price is any Regular -43, or -58 Formica Color
- Square Laminate Self Edge
- Kitchen/Vanity & Bar Tops

STEP 1 - BLANKS	3/4" Particle Core with perimeter Built up 1/2" Square Edges	3/4" Plywood Core with perimeter Built up 1/2" Square Edges	1 1/2" Solid Particle Core with 1 1/2" Solid Square Edges (3/4" Splash)	1" Particle Core with 1" Square Edges (3/4" Splash)	1 1/8" Particle Core with 1 1/8" Square Edges (3/4" Splash)	Add to Include Backer
	PER LINEAR FOOT					
19"or 22", or 25" Kitchen No Splash	\$26.40	\$62.10	\$53.50	\$45.90	\$50.00	\$7.50
19"or 22", or 25" Kitchen Loose 4" Splash	\$33.00	\$77.80	\$67.10	\$57.20	\$62.40	\$8.00
19"or 22", or 25" Kitchen Attached 4" Splash	\$34.20	\$80.80	\$69.60	\$60.00	\$64.70	\$8.00
3/4" Splash Only - 4"	\$11.80	\$24.90	\$11.80	\$11.80	\$11.80	\$1.00
3/4" Splash Only - Up to 18"	\$19.80	\$41.60	\$19.80	\$19.80	\$19.80	\$5.00
3/4" Splash Only - Up to 30"	\$29.00	\$61.30	\$29.00	\$29.00	\$29.00	\$8.00
Bar Top - Up to 18" Deep	\$21.30	\$41.62	\$35.80	\$30.70	\$33.30	\$5.00
Bar Top - Up to 30" Deep	\$35.50	\$62.12	\$53.55	\$45.90	\$50.00	\$8.00
Bar Top - Up to 36" Deep	\$42.60	\$75.28	\$64.50	\$55.80	\$60.00	\$10.00
Bar Top - Up to 42" Deep	\$49.70	\$87.80	\$76.00	\$64.90	\$71.00	\$12.00
Up to 18" Solid Buildup (for overhangs)	\$10.50	\$17.90	N/A	N/A	N/A	N/A

STEP 2 - ADDITIONAL DESIGN AND EDGE OPTIONS

1. 2 Side Chase with Splash	\$87.00	Add Flex 3mm PVC Edge (for curves & Radius) 12' Min	\$7.90 Per Linear Foot
2. 3 Side Chase with Splash	\$121.60	Add 3mm PVC Edge (for square and straight) 12' Min	\$3.60 Per Linear Foot
3. Cutout - Slide In	\$87.00	Add Unfinished Oak Edge * - 12' Min	\$47.70 Per Linear Foot
4. Grommet Hole	\$25.00	Add Maple, Cherry, Hickory Edge * - 12' Min	\$62.00 Per Linear Foot
5. Single Splay Corner	\$69.60	Add Formica C12 Ogee - 12' Min	\$39.50 Per Linear Foot
6. Laminate Miter	\$30.30	Add Formica D12 Bullnose - 12' Min	\$39.50 Per Linear Foot
7. Square Cut Notch	\$41.80	Add Formica E12 Double Radius - 12' Min	\$39.50 Per Linear Foot
8. Double Splay Corner with Shelf	\$127.30	Add Formica F12 Waterfall - 12' Min	\$39.50 Per Linear Foot
9. Laminate Seam	\$25.20	Add Wilsonart Bevel Edge - 12' Min	\$39.50 Per Linear Foot
10. Finished End Cap***	\$19.60	Add Wilsonart Crescent Edge - 12' Min	\$39.50 Per Linear Foot
11. Pass Through	\$96.60		
12. Bump Out	\$96.60		
13. Bump Up Splash	See Pricing Matrix		
14. Cutout - Non-Standard	\$52.30		
15. Loose Apron	Same as Splash		
16. Radius Corner (3" Min)	\$52.30		
17. Arc Radius End	\$69.80		
18. Full Radius End	\$116.00		
19. Clipped Angle Corner	\$52.30		
20. Cutout - Standard	\$35.10		
21A. Endsplash Loose***	\$26.30		
21B. Endsplash Attached***	\$28.40		
22. Endsplash Partial with End Cap***	\$41.80		

*Unfinished Wood Includes Eased Edge, Bullnose, Bevel Top, 3/8 Radius Top, or 3/8 Radius Top & Bottom Profile

STEP 3 - LAMINATE UPGRADE MULTIPLIER

BRAND	COLORS	FINISH CODE	MULTIPLIER
Formica	Regular	43,58	1
	Special	26,34,42,46,90,BH,ML,NG,PG,PX,SP,WR	1.1
	Ultra	PA,18OFX(any Finish)	1.5
	By Quote	MC	Call
Wilsonart	Regular	38,60	1
	Special	1,12,15,16,18,19,21,22,28,5,52,7,78,79	1.1
	Ultra	35,55,57,67	1.5
	By Quote	Any 'Y' or 'HD' color	Call
Pionite	Regular	SD,VE	1
	Special	GL,AW,CR,GR,LR,LZ,MG,PV,SM, SX,AB,FL,GV,SL,TL,TW	1.1
	Ultra	EV	1.2
	By Quote	AS,WE,BB,HX,IW,MZ,NS,NW	Call
Nevamar	Regular	SD,T,VE	1
	Special	GL,AW,CR,GR,LR,LZ,MG,PV,SM,SX, AB,FL,GV,SL,TL,TW	1.1
	Ultra	EV	1.2
	By Quote	AS,WE,BB,HX,IW,MZ,NS,NW	Call
Arborite	Regular	SD,T,VE	1
	Special	CA,FP,LE,RM,SR,UM	1.2
	Ultra	CW,IM,VL	1.3

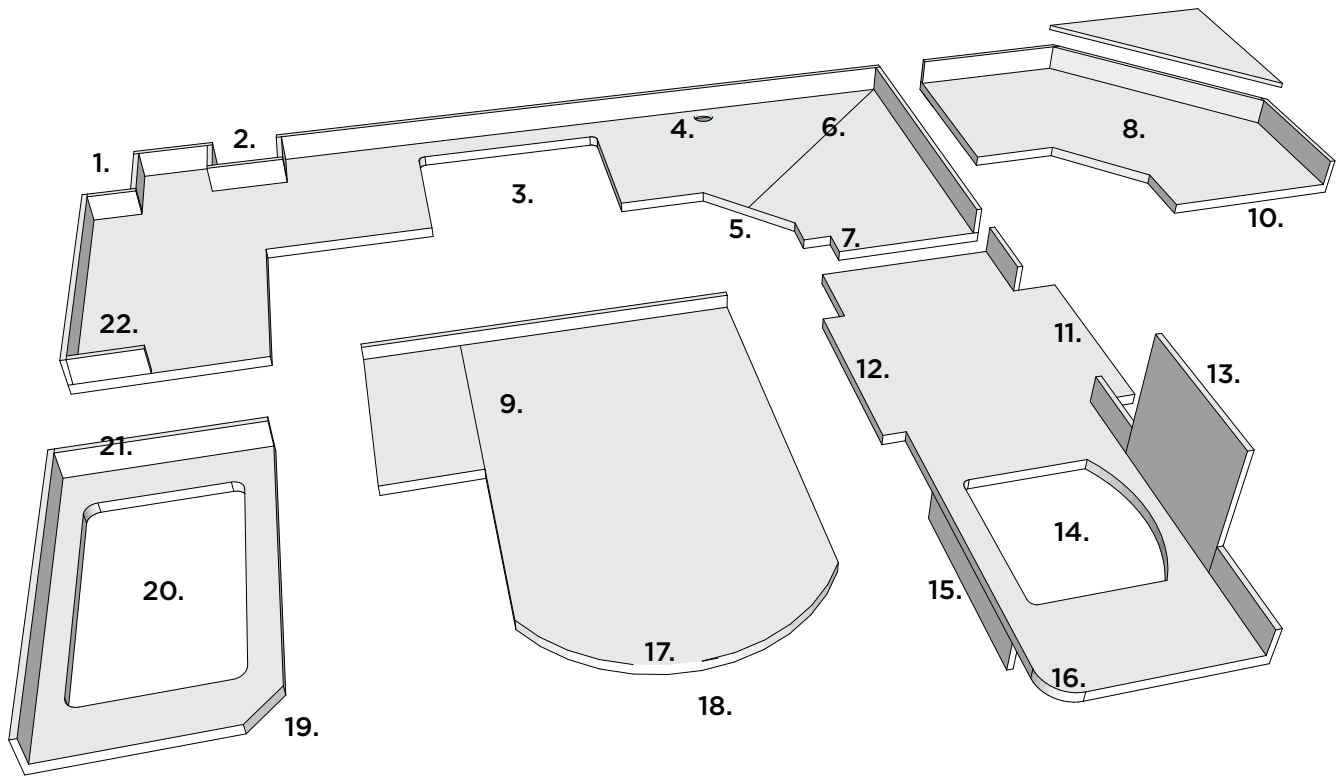

ADDITIONAL OPTIONS	COST PER ITEM
1. 2 Side Chase with Splash	\$87.00
2. 3 Side Chase with Splash	\$121.60
3. Cutout - Slide In	\$87.00
4. Grommet Hole	\$25.00
5. Single Splay Corner	\$69.60
6. Laminate Miter	\$30.30
7. Square Cut Notch	\$41.80
8. Double Splay Corner with Shelf	\$127.30
9. Laminate Seam	\$25.20
10. Finished End Cap***	\$19.60
11. Pass Through	\$96.60
12. Bump Out	\$96.60
13. Bump Up Splash	See Pricing Matrix
14. Cutout - Non-Standard	\$52.30
15. Loose Apron	Same as Splash
16. Radius (3"Min)	\$52.30
17. Arc Radius End	\$69.80
18. Full Radius End	\$116.00
19. Clipped Angle Corner	\$52.30
20. Cutout - Standard	\$35.10
21A. Endsplash Loose***	\$26.30
21B. Endsplash Attached***	\$28.40
22. Endsplash Partial with End Cap***	\$41.80

CUSTOM LAMINATE EDGE OPTIONS	COST PER ITEM
Add Flex 3mm PVC Edge (for curves & Radius) 12' Min	\$7.90 Per Linear Foot
Add 3mm PVC Edge (for square and straight) 12' Min	\$3.60 Per Linear Foot
Add Unfinished Oak Edge * - 12' Min	\$47.70 Per Linear Foot
Add Maple, Cherry, Hickory Edge * - 12' Min	\$62.00 Per Linear Foot
Add Formica C12 Ogee - 12' Min	\$39.50 Per Linear Foot
Add Formica D12 Bullnose - 12' Min	\$39.50 Per Linear Foot
Add Formica E12 Double Radius - 12' Min	\$39.50 Per Linear Foot
Add Formica F12 Waterfall - 12' Min	\$39.50 Per Linear Foot
Add Wilsonart Bevel Edge - 12' Min	\$39.50 Per Linear Foot
Add Wilsonart Cresent Edge - 12' Min	\$39.50 Per Linear Foot

OTHER AVAILABLE OPTIONS	COST PER ITEM
Dishwasher Area Backer	\$72.10 each
Add Laminate Backer Bottom	\$3.50 Per Square Foot
Removable Solid Core Insert	\$7.60 Per Square Foot
Laminate Both Side G2S	\$7.60 Per Square Foot
Loose Plastic Laminate Sheets Formica Regular Color 3' 4' or 5' X 8' 10' or 12'	\$4.00 Per Square Foot

* Unfinished Wood Includes Eased Edge, Bullnose, Bevel Top, 3/8 Radius Top, or 3/8 Radius Top & Bottom Profile

WOOD EDGE PROFILES



FLEXLINE™

ADA-COMPLIANT CONVERTIBLE VANITY CABINET



THE PERFECT COMBINATION

With a Flexline™ vanity combo, you can save time, expense and coordination hassles, while meeting ADA requirements.

EASILY CONVERTED

When a new resident requires an ADA-compliant vanity, or a current occupant's needs change, the Flexline can be easily converted in minutes using just a screwdriver. If wheelchair access is no longer needed, the Flexline can be changed back just as easily.

PERFECT FOR

- Retirement Communities
- Public Housing
- Residential Developments
- Any Facilities Serving Those with Physical Limitations

QUICK DELIVERY

You don't have to wait when you order Flexline by Rynone. Whether you order one or 100, your Flexline vanity cabinets and tops will arrive within three weeks. Expedited delivery can occur with special arrangements.

Shown on this page: Formica 9240-58 Cherry Heartwood Laminate Vanity Cabinet, Wheat Granite Top with Bisque Porcelain Bowl. Faucet and hardware not included.

FLEXLINE™

ADA-COMPLIANT CONVERTIBLE VANITY CABINET



Shown above: Natural Birch Wood Veneer Vanity Cabinet, Solid White Cultured Marble Top with Integral Bowl. Faucet and hardware not included.

EIGHT REASONS TO CHOOSE FLEXLINE CONVERTIBLE VANITY CABINETS

- 1 | **Convenient Versatility** / One vanity offers ADA compliance and stylish functionality for everyone.
- 2 | **Budget-Friendly** / Affordably priced, lowest long-term investment.
- 3 | **Simple Setup** / Installation and conversion can be done by anyone.
- 4 | **Beautiful Selection** / Design options for any décor from basic to luxurious.
- 5 | **Fast Delivery** / In three weeks or less.
- 6 | **Single Source** / One expert source for vanity cabinet and top.
- 7 | **Order Flexibility** / Large and small orders welcome.
- 8 | **Full Compliance** / Meets all ADA and Fair Housing Accessibility Guidelines.

FLEXLINE™

HOW IT WORKS

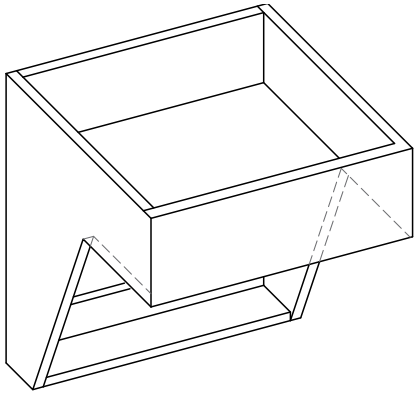

ADA VANITY

ADA vanity is available by itself without the removable base cabinet.

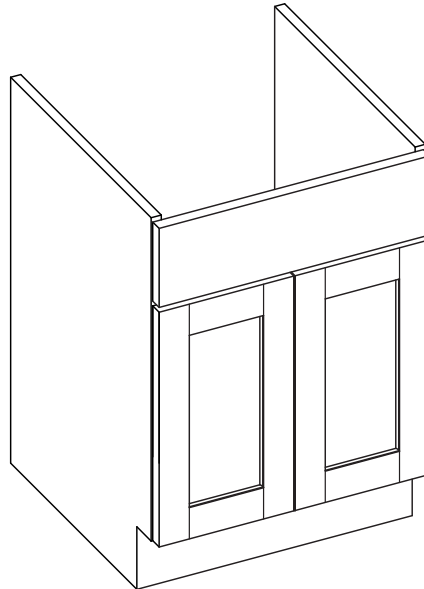

BASE CABINET

Base cabinet is easily installed over the ADA Vanity or removed when accessibility is needed. Also available without the ADA Vanity.

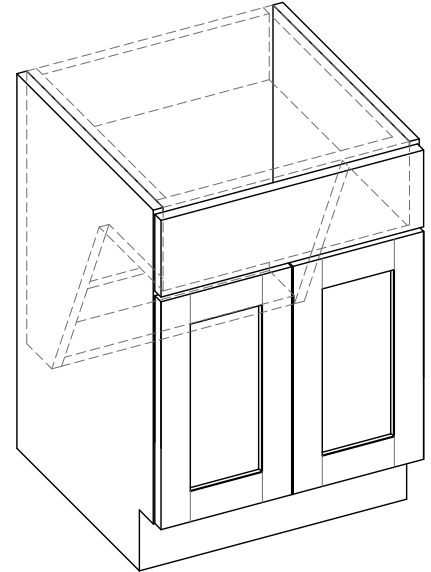

VANITY CABINET ASSEMBLED

Two smart vanity options in one clever, compact design.

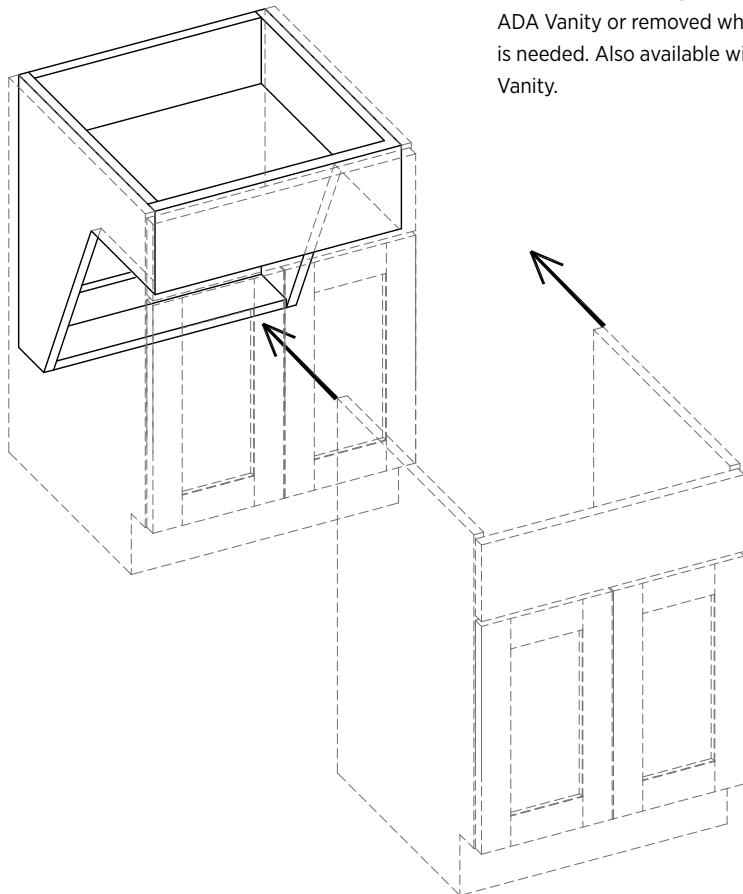

VERSATILE DESIGN OPTIONS

Flexline convertible vanity cabinets come in an attractive range of complementary design options. Choose from several sizes, materials, finishes, and drawer and door styles.

CUSTOM OPTIONS

Other custom options are also available by contacting a Rynone customer care specialist at (570) 888-5272 or CustomerService@FlexlineVanityCabinet.com.

AVAILABLE IN HUNDREDS OF LAMINATE CHOICES, INCLUDING THESE POPULAR COLORS

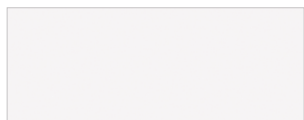

FORMICA® 949-58 White

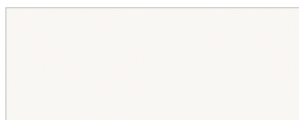

FORMICA® 7197-58 Dover White

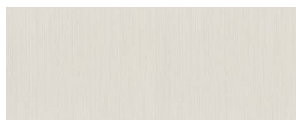

FORMICA® 9285-58 White Twill

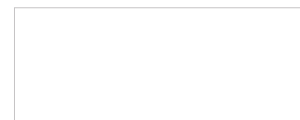

Cultured Marble / Solid White



FORMICA® 927-58 Folkstone



FORMICA® 961-58 Fog



FORMICA® 8826-58 Neutral Twill

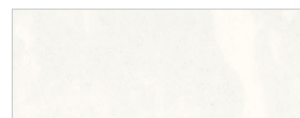

Cultured Marble / White-on-White

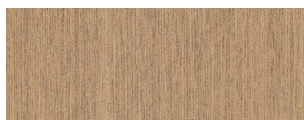

FORMICA® 5883-58 Pecan Woodline

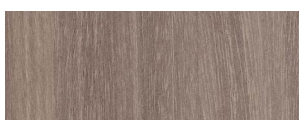

FORMICA® 8845-58 Bleached Legno

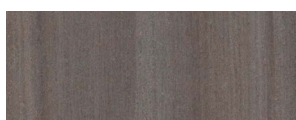

FORMICA® 5488-NT Smoky Brown Pear

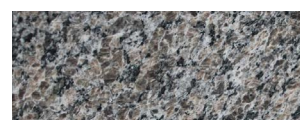

Granite / New Caledonia



FORMICA® 7012-58 Amber Maple

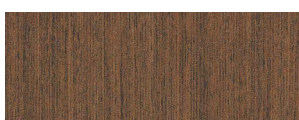

FORMICA® 5884-58 Chestnut Woodline

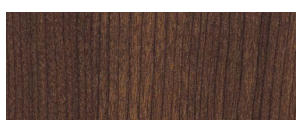

FORMICA® 5886-43 Sorrel Cherry

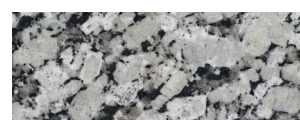

Granite / Iberian White



Real Wood Veneer / Oak



Real Wood Veneer / Maple



Real Wood Veneer / Cherry



Granite / Santa Cecilia Lt

DOOR AND DRAWER FRONT STYLES



Melamine, Laminate, or Real Wood Veneer Slab Door



Real Wood Shaker Flat Panel



Real Wood Raised Panel



Quartz / Carrara Verta

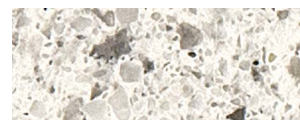

Quartz / Ocean Gray



Quartz / Iceberg

Cultured Marble Tops come with integral bowls the same color as the top. Other color options are available.

Wood and granite are products of nature; variations in grain, pattern and color are inevitable. Cultured marble is a man-made product that will vary in pattern.

SPECIFICATIONS

Flexline Convertible Vanity Cabinets come in eight standard widths: 24", 27", 30", 33", 36", 39", 42" and 48" (Four sizes are illustrated below.)

Vanity Cabinet height – 32½" (without top)

Vanity Cabinet depth – 21" (without top)

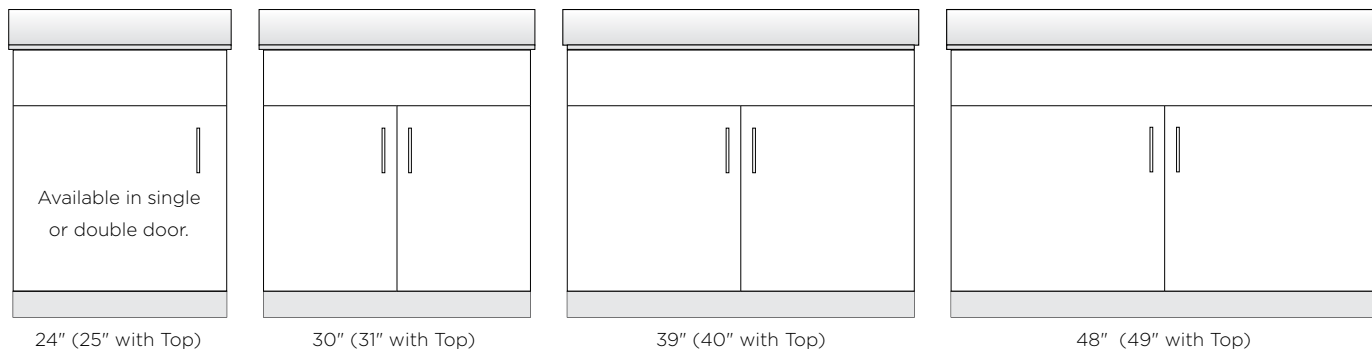

COMBINATIONS

Rynone Flexline Vanity Cabinets can be ordered as a combination or as individual components:

- Base Cabinet + ADA Vanity + Vanity Top
- Base Cabinet + Vanity Top
- ADA Vanity + Vanity Top
- ADA Vanity Only
- Base Cabinet Only
- Vanity Top Only

VALUE OPTIONS

Flexline offers Vanity Cabinet and Top options for every budget and design preference.

Beautiful Economy – Laminate Cabinet/Doors + Cultured Marble Top provide beautiful economy

Mix and Match – Laminate Cabinet/Doors + Granite Vanity Top, or Wood Veneer Cabinet + Solid Wood Doors + Cultured Marble Top

For a Luxury Look – Wood Veneer Cabinet + Solid Wood Doors + Granite Top

PLYWOOD OR PARTICLE BOARD CONSTRUCTION

STOCK ITEMS (LAMINATE)

- All ¾" components
- Concealed hinges
- Includes 96mm Satin Chrome Wire Pull

NON-STOCK ITEMS (WOOD VENEER)

- All ¾" plywood construction
- Concealed hinges
- Door/drawer front style
- Includes 96mm Satin Chrome Wire Pull

VANITY TOP SPECS

- Cultured Marble Tops come with integrated bowl and 4" backsplash.
- Granite Tops come with standard undermount porcelain bowl and 4" loose backsplash.
- Depth – 22¼"
- Thickness – ¾"

INSTALLATION

- Locate 2 wall studs to attach cabinet.
- Set cabinet to ensure it is level.
- Screw cabinet into studs using, at a minimum, 3" screws at upper and lower mounting rail.
- Before installing the vanity top, ensure it fits securely before gluing.
- Glue vanity top to wall-hung unit.
- **Do not glue top to removable base.**

BOX SIZES AND WEIGHTS (IN LBS.)

Cultured Marble		Granite		Cabinet	
Size	Weight	Size	Weight	Size	Weight
25	34.0	25	59.0	24	68.0
28	36.4	28	66.0	27	70.0
31	40.3	31	73.1	30	71.5
34	44.2	34	80.2	33	73.5
37	48.1	37	87.3	36	75.0
40	52.0	40	94.3	39	76.5
43	55.9	43	101.4	42	78.0
49	63.7	49	115.6	48	81.0

For more information or custom options, please contact us at (570) 888-5272 or CustomerService@FlexlineVanityCabinet.com

FOOTER	TITLE	PAGE CODE	EFFECTIVE DATE	PREVIOUS DATE
RYN0424FULLLINE	Cover		4/1/24	03/1/23
RYN0423PQV.1	Prism Quartz Vanity Tops		4/1/23	4/1/21
RYN0125PQV.2	Prism Quartz Colors		1/1/25	4/1/23
RYN0125QV2CMSTD	Prism Quartz 2cm Standard List		1/1/25	4/1/23
RYN0125QV2CMCUS	Prism Quartz 2cm Custom List		1/1/25	4/1/23
RYN0125GRV.1	Granite Vanity Tops		1/1/25	4/1/21
RYN0325GRV.2	Granite Vanity Colors		3/1/25	4/1/21
RYN0325GV2CMSTD	Granite Vanity 2cm Standard List		3/1/25	4/1/23
RYN0425GV2CMCUS	Granite Vanity 2cm Custom List		4/1/25	3/1/25
RYN0624QSV.1	Prism Quartz SlimLine Vanity Tops		6/1/24	-
RYN0624QSV.	Prism Quartz SlimLine Colors		6/1/24	-
RYN0624QSV1.5CMSTD	Prism Quartz SlimLine 2cm Standard List		6/1/24	-
RYN0624QSV1.5CMCUS	Prism Quartz SlimLine 2cm Custom List		6/1/24	-
RYN0421GQVEDGES	Granite and Quartz Edge Profiles		4/1/21	4/1/20
RYN0625GQVPORUM	Vanity Top Bowls		6/1/25	1/1/25
RYN0325CMV.1	Cultured Marble Vanity Tops		3/1/25	4/1/24
RYN0325CMV.2	Cultured Marble Colors		3/1/25	4/1/22
RYN0425CMVSTD	Cultured Marble Standard List		4/1/25	2/1/25
RYN0325CMVCUS	Cultured Marble Custom List		3/1/25	4/1/24
RYN0421CMB	Cultured Marble Bowl Options		4/1/21	1/1/20
RYN0421CMBCUS/COR	Cultured Marble Top Options		4/1/21	9/18/18
RYN0125SSV.1	Solid Surface Vanity Tops		1/1/25	6/1/24
RYN0624SSV.2	Solid Surface Colors		6/1/24	4/1/23
RYN0325SSVPORSTD	Solid Surface UM Standard List		3/1/25	6/1/24
RYN0325SSVINTEGSTD	Solid Surface Integ Standard List		3/1/25	6/1/24
RYN0325SSVCUS	Solid Surface Custom List		3/1/25	6/1/24
RYN0222GQVSS/SS.1	SolSurf & Stainless Bowl Options		2/1/22	4/1/21
RYN0125SSTROUGH.1	Custom Trough Sink Sell Sheet		1/1/25	4/1/21
RYN0125SSTROUGH.4	Custom Trough Sink List Price		1/1/25	6/1/24
RYN0421BUTCHERBLOCK.1	Butcherblock Tops		4/1/21	11/1/20
RYN0626BUTCHERBLOCK.2	Butcherblock Tops List Price		6/1/26	4/1/21
RYN0125LAMCT	Plastic Laminate Tops		1/1/25	4/1/21
RYN0422PPF	Postform Edge Profiles		4/1/22	4/1/21
RYN0325PPFB	Particle core Postform Tops		3/1/25	6/1/24
RYN0325PFPLY	Plywood Postform tops		3/1/25	6/1/24
RYN0125SE	Custom Plastic Laminate Tops Standard		1/1/25	6/1/24
RYN0125SEO	Custom Plastic Laminate Tops		1/1/25	5/1/24
RYN0421FLEX.1	Flexline Sell Sheet		4/1/21	11/1/18
RYN0421FLEX.2	Flexline Details		4/1/21	11/1/18
RYN0421FLEX.3	Flexline Construction		4/1/21	11/1/18
RYN0125FLEX.5	Flexline Design Options		1/1/25	5/1/22
RYN0522FLEX.6	Flexline Specifications		5/1/22	4/1/21
RYNWORKSHEET	Custom Vanity Top Worksheet		6/1/24	-
RYN0325INDEX	Page Index		3/1/25	12/1/22

CUSTOM VANITY TOP WORKSHEET

RETURN FORM WITH PO BY FAX: 570.888.1175

BILL TO:

PURCHASE ORDER NUMBER _____

LOCATION _____

CONTACT _____

ADDRESS _____

CITY _____ STATE _____ ZIP _____

PHONE _____ FAX _____

EMAIL _____

SHIP TO:

Location _____

To Call/Email with any questions on this order:

PHONE _____

EMAIL _____

I have reviewed all of the information and understand that this custom vanity top order cannot be cancelled or returned after the order is placed.

AUTHORIZED SIGNATURE _____

Vanity Top Material

- | | | | |
|--------------|-------------|-----------------|---------------|
| 1.5cm Quartz | 2cm Quartz | 3cm Quartz | Solid Surface |
| 2cm Granite | 3cm Granite | Cultured Marble | Other |

Vanity Top Color

GROUP # _____

COLOR # _____

COLOR NAME _____

Vanity Top Dimensions

Depth: 19 1/4" 22 1/4" Width* _____

*Tops can be sized to the nearest 1/8" of an inch.

Bowl Options

No Bowl No Cutout

Cultured Marble		Porcelain		Solid Surface	
Depth	19 1/4" 22 1/4"	Depth	19 1/4" 22 1/4"	Depth	19 1/4" 22 1/4"
Color	White Biscuit	Color	White Biscuit	Color	White Bisque
Shape	Oval Recessed Oval Rectangular Rectangular Recessed Recessed Shell Wave (NEW) Other manufacturer's bowl cutout	Shape	Small Oval Large Oval Large Oval in Black Rectangular	Shape	Oval Rectangular

Bowl Location – Minimum 12" from edge

Single Bowl Centered _____" from left edge
Offset C/L "A" _____" from left edge

Double Bowl Bowl "A" C/L _____" from left edge
Bowl "B" C/L _____" from right edge

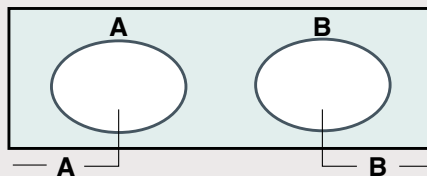
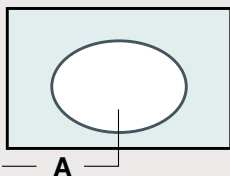

Faucet Hole Options

- | | | |
|--------------------|--------------|--------------|
| No Hole | 8" Straight | 4" Centerset |
| Single Center Hole | 8" Contoured | |

Edge Profile Options

Cut Edge Unfinished – No Charge
Upgrade Profile Options (see price sheet)
(Cultured Marble only available in Eased Edge.)

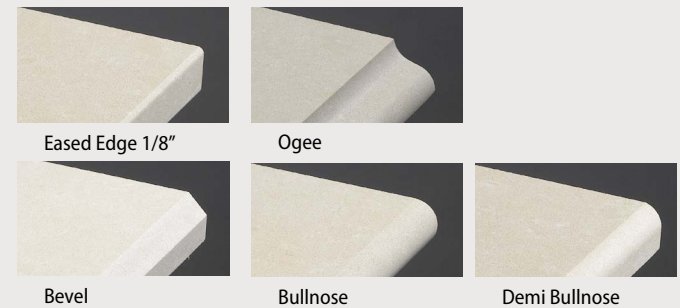

Finished Ends

(Specify location of side walls or linen towers that will directly contact the vanity top)

- | | | |
|------------------|-------------------|------|
| Left | Right | None |
| Linen Tower Left | Linen Tower Right | |

Endsplash

- | | | |
|------|------|-------|
| None | Left | Right |
|------|------|-------|

Back Splashes

Loose 4" Backsplash included – Eased front edge only

Pricing Calculation

Vanity Top Deck		\$
Bowl Price		\$
Double Bowl Price		\$
Edge Treatment Price		\$
Endsplash		\$
Options – Add On		\$
TOTAL		\$

